



saunum

Saunum Sauna Control Unit **AirIQ**



THE BEST SAUNA EXPERIENCE TO HAVE!



I am very glad that you have invested in the Saunum device, and I believe that our innovative technology will offer you a wonderful and extraordinary sauna experience.

I have a degree in thermal engineering and come from the Southern Estonia, where my love for saunas began. The special feature of local historic smoke saunas is the lower temperature and higher humidity level than, for example, a classic Finnish sauna. In ordinary saunas, the stone volume of the sauna heater is generally small. Such an arrangement can cause a sudden, burning hot steam and an extremely uneven temperature, where your head and shoulder level is really hot, but your feet are left cold. Such an experience can be quite unpleasant and may cause headaches and lead to body stress. However, in ancient smoke saunas and Native American saunas, the stones were first heated during the day. Then the heat stored in the stones was used to cleanse the body and create a truly enjoyable sauna experience.

Inspired by the experience of a smoke sauna, I wanted to create an innovative solution that combines the best features of an authentic sauna with modern technology; enabling a pleasantly mild and relaxing sauna experience without painfully scorching steam. For that, however, I had to solve the problem of how to achieve an even temperature, at both the head and foot levels. My development work was supported by research done alongside Tallinn University of Technology,



in which we analysed the thermal stratification and air movement in the sauna room. Saunum was born in cooperation between scientific thinking and technological innovation.

Saunum's unique patented mixing system of air layers captures the hot steam that rises under the ceiling of the sauna room, mixes it with the cooler air from the surface of the floor, and directs the milder steam back evenly. This makes for an enjoyable, unaggressive heat. You can sit in the sauna for a longer time, and enjoy a sweat and a deep cleanse without feeling tired. The stone volume of our heaters is significantly larger than other sauna heaters, which is the reason for the especially pleasant indoor climate with long and soft steam.

A moist steamy sauna, a sanarium, a therapeutic salt sauna, or a healthy aroma sauna – all of these functions are available on Saunum's devices to create a truly relaxing sauna experience. When using Himalayan salt balls in our device, salt ions that are beneficial to skin and respiratory tract evaporate and the steam circulates these into the air. Adding a sauna aroma system that blends steam and healthy aroma oil creates an even more enjoyable sauna environment.

Saunum's sauna devices are suitable for both adults and children.

Have a pleasant sauna!

Andrus Vare
The creator of Saunum



CONTENTS

Saunum **congratulates you** on choosing an innovative sauna control unit!

Warnings and notes _____	6
DIRECTION FOR USE	
Using the heater and instructions for bathing _____	8
Control unit set _____	9
Remote Control _____	10
Indicators _____	11
Heating _____	12
Using the Saunum sauna climate function _____	12
Configuring the sauna _____	13 - 17
Sauna scheduling _____	18
Technical data _____	20 - 21
INSTRUCTIONS FOR INSTALLATION	
Electrical connections _____	22
Installing the control panel _____	23 - 24
Installing the temperature sensor _____	25
Installing the door sensor _____	26
Solving problems - thermal cutoff _____	27
Warranty conditions _____	28 - 29
Installation report _____	30



All users of this product must read the warnings and manual carefully before using the product! Failure to follow the instructions could result in personal injury, death, fire, and/or property damage, and the device's warranty may be voided.

The control panel is meant for controlling the sauna heater and the functions intended for the control unit set.

It is not to be used for any other purpose!

This device should not be used by children, people with reduced mobility or sick people. Children should use the device only under constant and close adult supervision.

Persons with reduced physical, sensory, or mental capabilities, or persons with a lack of experience and knowledge, should use this device only under constant and close adult supervision and only after consulting with a physician.

Before using sauna, all users should consult with a physician to ensure that they have no health conditions that would make sauna bathing unsafe, and discuss time and temperature limitations. Pregnant women should consult their physician before the use of the sauna. Excessive body temperatures have the potential to cause fetal damage during early pregnancy.

Use of drugs, medication, or alcohol before or during the sauna session may lead to dizziness or unconsciousness, resulting in injury or death. No person should use this product while under the influence of alcohol or drugs. Persons taking medications should consult with their physician to ensure that it is safe to use sauna while taking their medications. Users should place a towel between their skin and sauna bench or wall while sitting or lounging in the room. When using the sauna, be aware of the dangers associated with going to the sauna. Do not stay in the sauna steam room for more than 30 minutes at a time.

Prolonged exposure to steam can be harmful or fatal. Users should discontinue using



the sauna if they feel light-headed, dizzy, or experience heat exhaustion. It is prohibited to sleep inside the heated sauna. Users should take care to avoid falling asleep while using the sauna.

The electrical device should only be connected to the power and/or utilities in accordance with all laws and regulations by a licenced, professional, certified electrician.

After connecting and installing the control unit set, the installer must inform the sauna owner or operator of all operating requirements.

The requirements for use must be given by the owner or operator to everyone who uses the sauna.

All maintenance other than regular surface cleaning of the product must be performed by a trained professional.

Always disconnect the device from the power and/or utilities before carrying out any maintenance work!

- Check the control unit set for visible damage before installation and use. Do not use a damaged device or a device that has been modified from the original manufacturer's condition in any way.

- It is vital to install the device according to the instructions for installation and use. Failure to carefully follow all instructions can cause the risk of fire or short-circuit, leading to property damage, bodily injury, or death.
- No accessories that the manufacturer has not approved should be installed in this device. If suitable accessories are installed in the device, follow the accessory-specific operating and installation instructions!
- If the supply cord is damaged, it must be replaced by the manufacturer's service partner or a similarly qualified licensed, professional, certified electrician to avoid a hazard.
- Clean the control panel by using a lightly moistened cloth. Use only mild cleaning agents, never solvents or corrosive chemicals. Allow the product to dry thoroughly before operation.
- This product should not be disposed of with general household waste. When recycling your product, take it to your local collection facility or contact the place of purchase.



USING THE HEATER AND INSTRUCTIONS FOR BATHING

- Always check before heating that there are no objects on the heater or near the heaters safety distance described in the heaters manufacturers manual.
- Always check that the heater has switched off and stopped heating after the on-time period has elapsed.
- In public saunas, where the heater is used continuously for longer than the heater timer or the control unit allows for in the factory settings, the device must only be used under constant adult supervision by a person not using the sauna while performing the supervision.
- When the control unit is set to standby mode for remote control or switching, it must be ensured in advance that there are no objects in the steam room or on the heater that do not match the safety distances specified in the heater manufacturer's instructions.
- According to the product UL standard regulating electrical sauna heaters, the control unit can be used to remotely control the heater once the heater or sauna room door is equipped with a safety switch (door sensor).
- Prolonged sauna use can damage your health or cause death.
- Do not stay in the steam room for more than 30 continuous minutes (in a row).
- Leave the steam room if you feel sleepy, dizzy, or weak.
- Do not dry objects or living things in the sauna.



CONTROL PANEL SET

The Saunum AirIQ sauna control panel set consists of **a control panel (1), a control panel cord (2), a temperature sensor (3), a temperature sensor cord (4).**

In addition, the box contains a set of **Himalayan salt balls** and **2x rubber grommets** for signal cable.

The control panel can be used to pre-set the temperature and start time of the heater and to switch the Saunum sauna climate device fan speed.

The temperature of the sauna room is regulated based on sensor information.

The temperature sensor and the overheat protector are located on the temperature sensor.

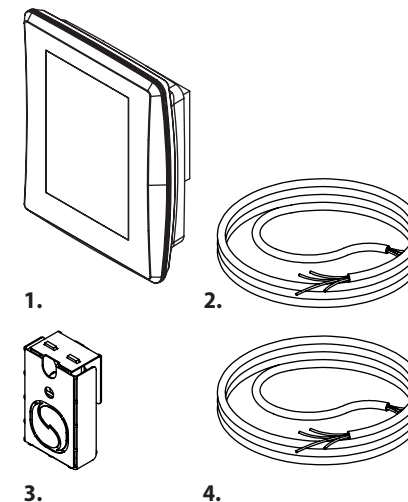



USING THE HEATER

WITH THE CONTROL PANEL

The heating elements will automatically turn off when the sauna room reaches the temperature selected on the control panel.

The control unit set will automatically turn the heating elements on and off to maintain the desired temperature.

The heater will turn off when the set time ends, the "Stop" button is pressed, or an error occurs.

CONTROL PANEL SET

- Controls the sauna temperature and the speed of the Saunum sauna climate device.
- Enables three pre-set sauna types that can be changed and update by the sauna owner.
- Enables the user to select a time for the sauna to be ready for entry and enjoyment.
- Shows notification when the sauna is ready – screen notification. Using the Saunum App, and on the mobile app.
- Languages.
- Touch screen.
- Screen lock / Child lock.
- Overheating protection.

- The desired functions can be selected from the intuitive screen, the numerical values displayed in red can be changed.
- Remote control – with the Saunum mobile app.

Devices with in-app support enabled can also be controlled and configured via a mobile phone.

The remote control of the heater can be used only when a safety door sensor has been installed (according to the product UL standard regulating electrical sauna heaters).

The heater can only be switched on remotely when the door is closed. If the circuit is open, the heater will not start.

After completing of the control unit set, the installer should give this manual to the owner of the sauna. The product owner should provide access to the manual to all persons using or operating the sauna. Please read more instructions for installation, use, and recycling in the original user manual of the control unit. Saunum reserves the right to modify this manual from time to time, and modifications will be posted to www.saunum.com. Failure to follow the instructions could result in personal injury, death, fire, and/or property damage, and the device's warranty may be voided.



INDICATORS



“Sauna ready” starting time



Temperature



Sauna duration



Ventilator



Ventilator speeds



Light



Heater power kW



Glass surface volume



Sauna room volume



Screen lock / Child lock



Move to next view



Value increase



Value decrease



Repeat sauna session

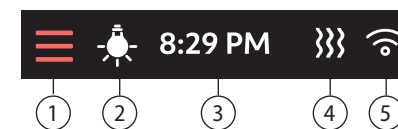

1. Menu
2. Light
3. Time
4. Heater state
5. Wi-Fi connection



HEATING

1. Tap the screen to get started.



Setting a sauna ready time.

The "sauna ready" time is when the sauna's steam zone temperature has reached the selected temperature level (heating starts approximately 1.5 hours earlier).

2. Tap the "Start" button to start heating the sauna.

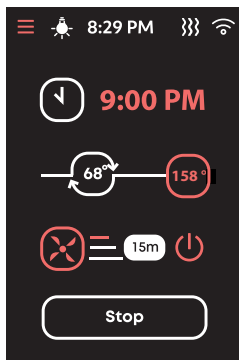
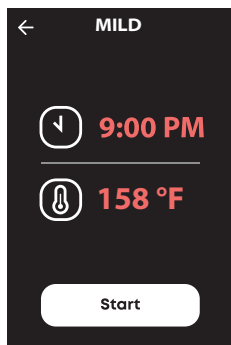

While the sauna is in heating mode, it is possible to change the duration of the sauna session, and the temperature by tapping on the duration and temperature controls and selecting the desired numbers.

USING THE SAUNUM SAUNA CLIMATE FUNCTION

WARNING! The fan function should not be used while heating the sauna steam zone, as it can result in a prolonged heating time and potential overheating.

Use the fan function of the sauna steam zone ONLY when using the sauna. To protect the sauna from overheating, the fan can also start independently. Do not use the fan function unattended.



CONFIGURING THE SAUNA

1. The "Set up" option will show on the first run. Tap "Set up" to begin the setup process.



2. Connecting to Wi-Fi.

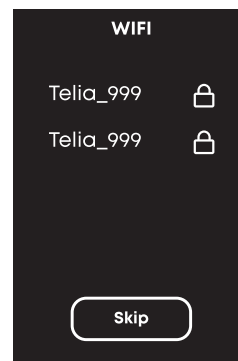

Select the appropriate Wi-Fi network by tapping on the corresponding network

name. If there is no need to connect the sauna control panel to the Wi-Fi network, tap the "Skip" button.

Install the control panel in a location with a good Wi-Fi connection. You can ensure an adequate Wi-Fi connection with your phone:

- Disable the mobile data on your phone.
- Turn on your phone's Wi-Fi.
- The Wi-Fi connection at the installation location is adequate if the Wi-Fi connection of your phone is good, and the applications that require data transfer work properly.

If the connection is not adequate:

- Try another location.
- If possible, change the location of your Wi-Fi router so that the connection to the Saunum Wi-Fi control panel is better.

The building structure, building materials, flush mounting, and other issues may reduce the quality of the Wi-Fi connection.

Tip! A Wi-Fi network extender can be used to enhance the network reach.

The Saunum Wi-Fi control panel is designed to control the electric sauna heater.



With the control panel, it is also possible to:

- Set and monitor the sauna temperature.
- Switch on and set the speed for the Saunum sauna climate function.
- See the heater status information.
- Set a scheduled start.

The Saunum Mobile App is a mobile application that allows you to control the Saunum control panel remotely.

3. Downloading the Saunum app.

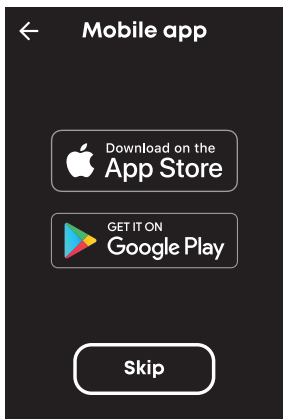

If there is no need to use the mobile application, tap the "Skip" button.

4. Opening the Saunum app download.

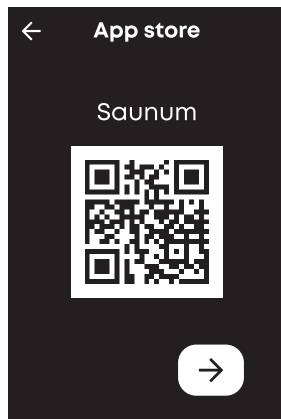

Scan the QR code that opens the Saunum app on Google Play or the App Store.

5. Connecting to the Saunum application, scan the QR code displayed on the control panel.



6. Setting the time zone.

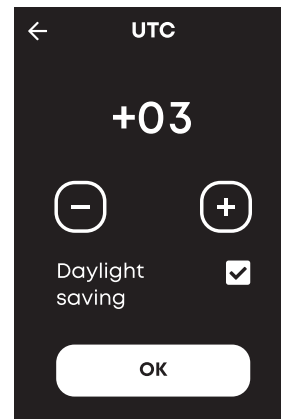

The local time zone (UTC) configuration is required if the sauna control panel has been previously connected to the Wi-Fi network.

7. Setting the date and time.

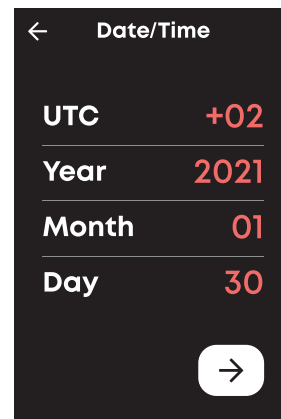

8. Setting units (1/2).

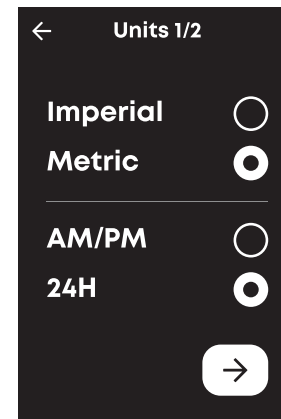

9. Setting the temperature unit (2/2).

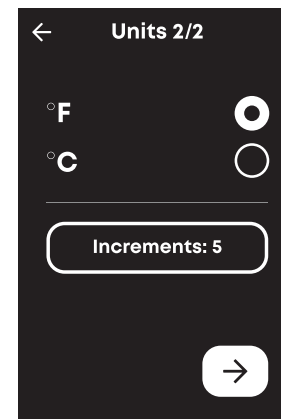



10. Entering sauna data (1/3 to 3/3)

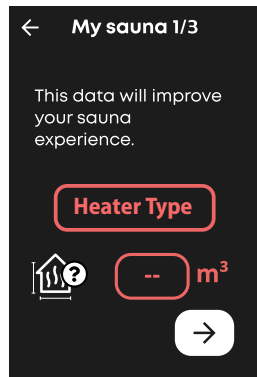

1/3

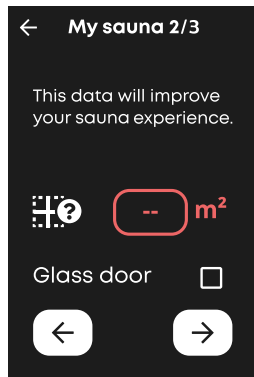

2/3

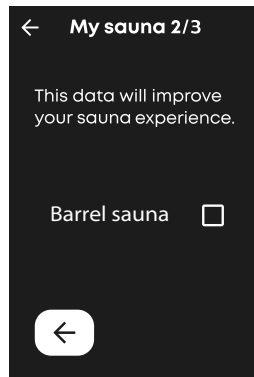

3/3

11. Setting passwords (default access password is 2002).

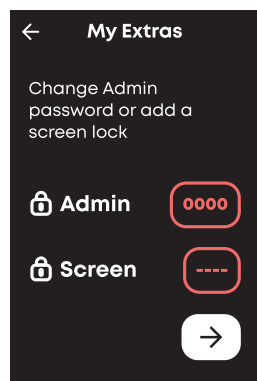

12. Creating a sauna type (1/4 - 4/4)

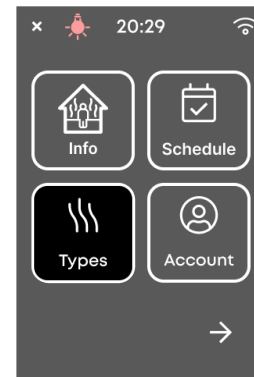

1/4 Select "Types"



2/4 Give a name - OK

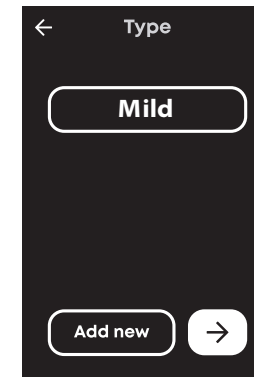

3/4 Give a name



Set temperature

Set ventilator speed and working duration

Set sauna session duration

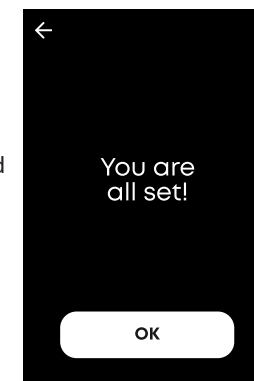

4/4 Pre-set sauna session parameters - OK



SAUNA SCHEDULING

Saunum allows you to schedule a sauna in advance by setting up a weekly schedule.

1. Open the Menu ①.



Always make sure the heater and area around the heater are clear before a scheduled sauna session.

2. Open the Schedule and set the desired day

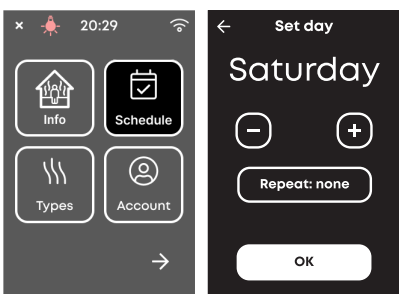

Before the selected time arrives, a message will appear stating that the heating session will start soon.

You can cancel the session by tapping "Cancel".

If you do not cancel it, the session will begin and, after the desired temperature is reached, it will run for 30 minutes, after which time it will stop unless the session is manually confirmed.

3. Setting the time.

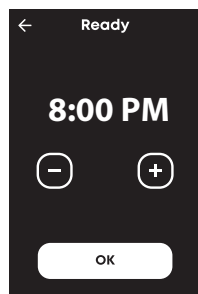

4. Setting the sauna type.

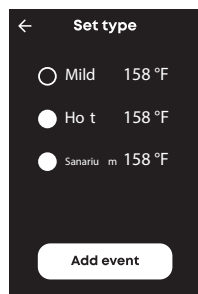

Series of horizontal lines for notes.



TECHNICAL DATA

CONTROL PANEL (IP20):

- Temperature adjustment range 104–194 °F.
- Pre-setting the schedule for the week.
- Allows you to set the operating time of 1 hours in a private and a public sauna.
- For longer operating times, consult the importer/manufacturer.
- Saunum climate device fan three-speed control.
- Dimensions: 0.8 in. × 3.3 in. × 4.1 in.
- Working temp. range -4°F up to 122°F.



POWER UNIT (IP44):

- Supply voltage: 240V N~.
- Heater power rating up to 15.2 kW.
- Dimensions: 2.36 in. × 10.11 in. × 6.5 in.
- Safety device: overheat protector.

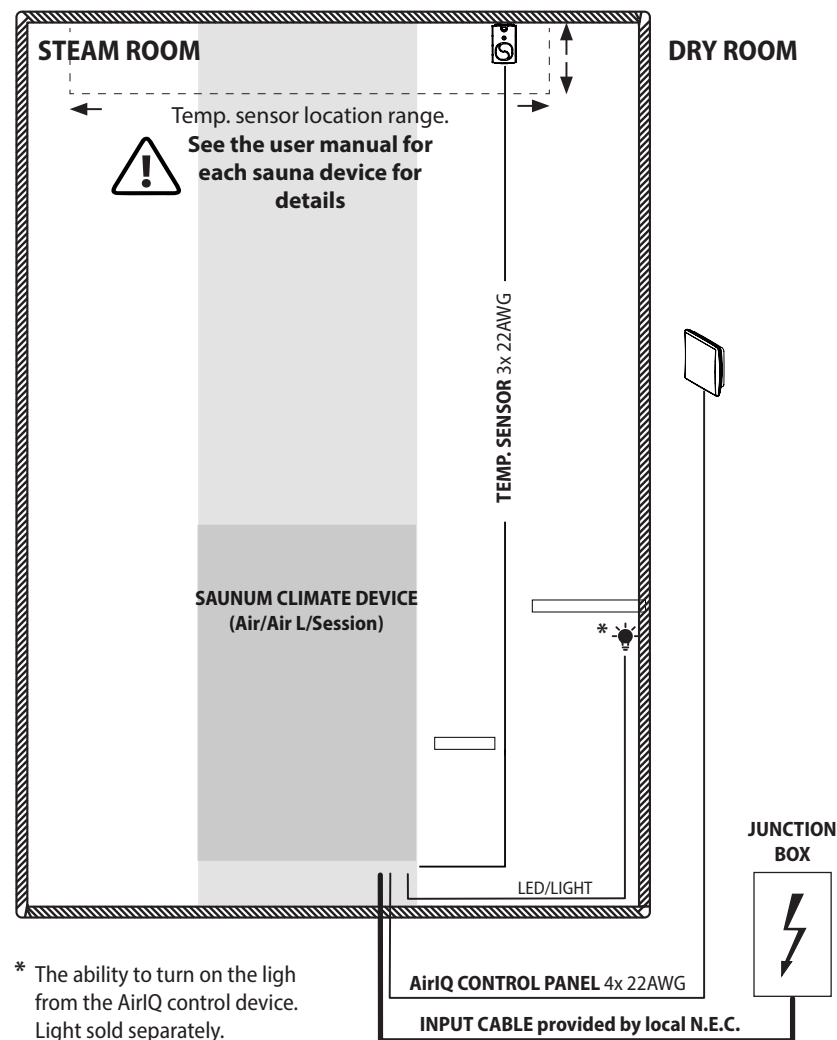

* The ability to turn on the light from the AirIQ control device. Light sold separately.



ELECTRICAL CONNECTIONS

The connection of the power unit is shown on the diagram of electrical connections.

For more information on connecting the heater, see the heater installation and operating instructions.

- If the connection and installation cables are located higher than 40 in. from the floor of the sauna room or inside the walls of the sauna room, they must be able to withstand a temperature at least 257°F (e.g., SSJ). Electrical equipment installed in the steam room below 40 in. from the floor must withstand a temperature of at least 194°F (e.g., T125).

RECOMMENDED CABLE DIAMETERS

Temperature sensor - thermal protection (silicon or other heat resistant material that is able to withstand a temperature at least 284°F):	min 4 x 22 AWG
---	----------------

Control panel (a ferrule extension sleeve is required for stranded cables):	min 4 x 22 AWG
--	----------------



INSTRUCTIONS FOR INSTALLATION

WARNING! Failure to install the product in accordance with all instructions here-in will void the warranty. It can result in the risk of fire and/or electrical short-circuiting, leading to property damage, bodily injury, or death.

A licensed professional electrician may only do the installation of the control unit in accordance with current regulations. The person in charge of the installation should provide the necessary training and return the user manual to the product owner after completing the installation. The product owner should provide access to the manual to all persons using or operating the product.

INSTALLING THE CONTROL PANEL

For concealed installation, the data cable can be installed in a protective tube with a diameter of 1/2 in. inside the wall; if this is not possible, it must be installed on the wall surface.

The control panel must be installed on the wall, in a place protected from water splashes.

1. Remove the wall mount from the device.

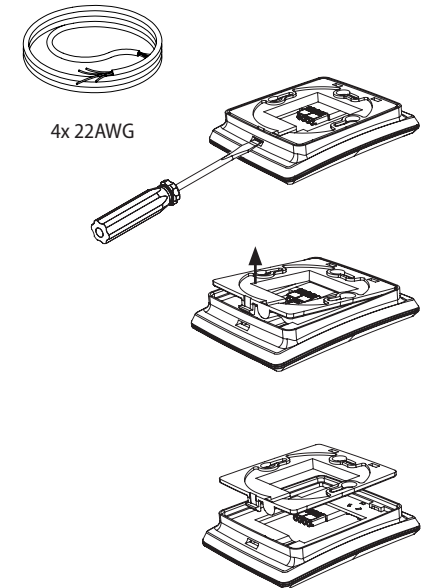

2. Thread the data cable through the hole in the wall mount and fasten the wall mount to the wall with screws.

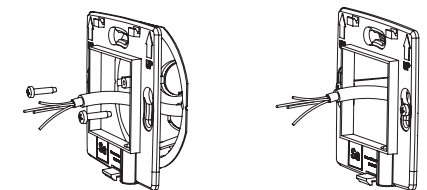

3. Connect the data cable to the Air IQ panel connector.

4. Press the Air IQ control panel into the wall mount.

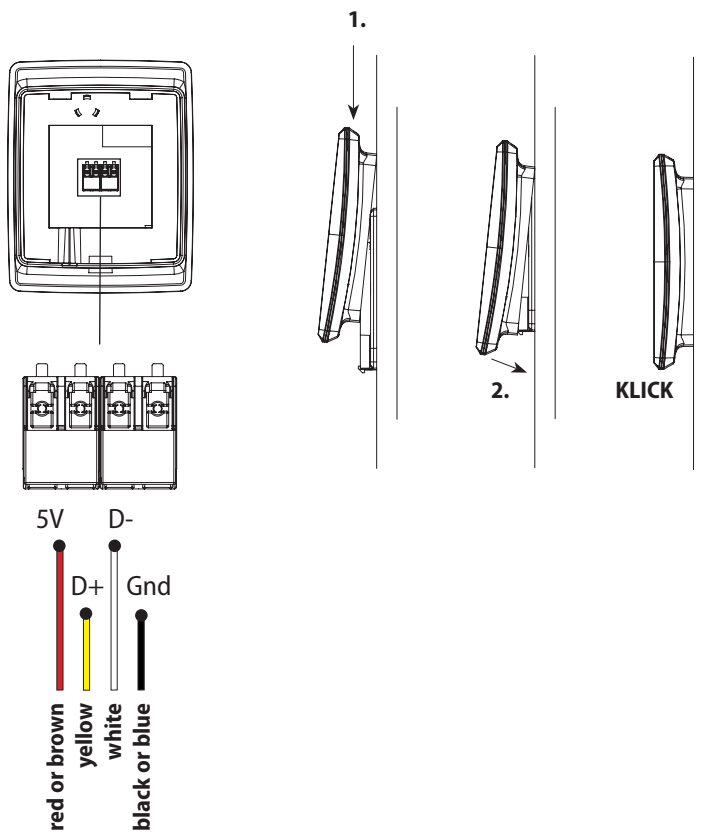

INSTALLING THE TEMPERATURE SENSOR

To install the temperature sensor/overheating protection, proceed as follows.

- Connect the cable to the temperature sensor's plugs.
- Screw the temperature sensor onto the wall (see figure).
- The temperature sensor cannot be placed above the heater. See the user manual for each Saunum climate device (Air/Air L, Session) for details.

The temperature sensor can't be any air opening (ventilation, door, or window).

The airflow near an air vent cools down the sensor, giving the control unit inaccurate temperature readings.

As a result, the heater might overheat.

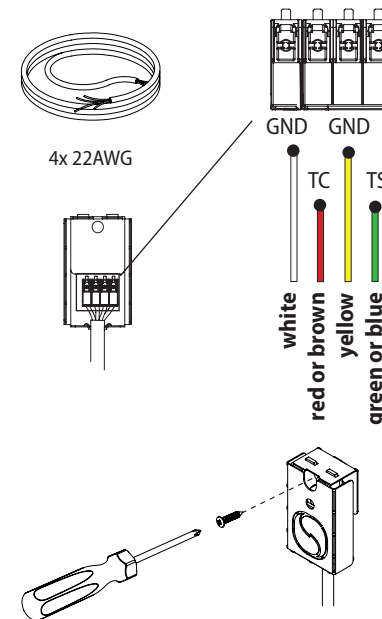



Air IQ control panel is displayed "THERMAL CUTOFF" - the thermal protection on the temperature sensor and/or Saunum climate device is activated, resulting in the fan and the device stopping for safety.

To restart the device, cool the steam room approx. 5-10 minutes 68°F lower by keeping the steam room door open and restarting the temperature sensor- and/or Saunum climate device safety switch by pressing the sensor brown safety switch until you hear a click.

NOTE! The reason for the switch-off must be clarified before the reset.

NOTE! The location of the device safety switch is shown separately in the device manual.

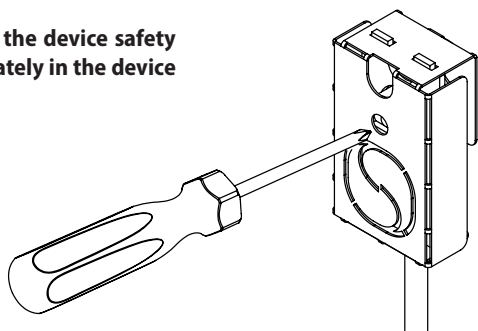
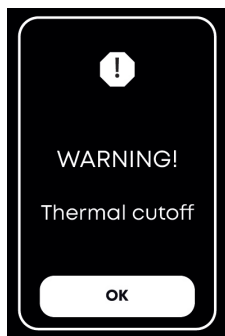

WARRANTY CONDITIONS

The Saunum warranty starts from the date of purchase and includes all manufacturer-provided parts of the control unit. The warranty covers faults from the manufacturing and materials only. Under this warranty, Saunum will provide replacement parts to the buyer, but only after the faulty parts have been returned to the manufacturer or reseller. Replacement of any part in the control unit by Saunum does not extend the original warranty period.

The electrical device should only be connected to power and/or utilities in accordance with all laws and regulations by a licensed, certified electrician.

The warranty applies only to the first installation of the product and to the original purchaser.

- The warranty is only valid if a completed installation report is submitted with the claim;
- The device is connected to the the power and/or utilities in accordance with all laws and regulations by a licensed, certified electrician;
- A warranty period of two (2) years applies to the Device if it is used in a private sauna;

- A warranty period of one (1) year applies to the Device if it is used in a public sauna.

The warranty does not cover:

- Routine maintenance and cleaning of the device, and replacement of the components due to normal wear and tear;
- Adaptation or modification of the device for any purpose other than that indicated in the instructions for use;
- Risks arising from transport;
- Damage resulting from the misuse of the device;
- Damage resulting from the improper installation of the device;
- Repairs to the device not carried out by Saunum's recommended repair and maintenance partner;
- Accidents, lightning, water, fire, improper ventilation, or any other factor beyond the control of Saunum.



INSTALLATION **PROTOCOL**

Saunum sauna's control unit model: _____

Date of purchase: _____

Original purchaser: _____

Place of installation: _____

Purchased from: _____

Date of electrical installation: _____

Signature of the installer: _____

Notes: _____

Customer's contact (name, email address): _____

Work accepted: _____

Start date of warranty: _____

Read all of the instructions for use carefully and thoroughly **before using the device** and keep them in a safe and easily accessible place for future reference.





Manufacturer: Saunum Saunas North America LTD
Telliskivi Tn 60-1,
Põhja-Tallinna Linnaosa, 10412
Estonia

declares that the product:

Saunum Sauna Control Unit Set Air IQ

complies with the requirements of the following directives of the Council of Europe, provided that the installation has been performed in accordance with the installation instructions issued by the device manufacturer and the instructions EN 60 204-1 "Safety of the machinery. Electrical equipment for the machinery –

Part 1: General requirements":

Machinery Directive 2006/42/EC

Low Voltage Directive 2014/35/EU

Electromagnetic Compatibility Directive 2014/30/EU

These products do not contain hazardous substances in excess of 0.1% (SVHC) and meet the requirements of the REACH Regulation (1907/2006/EU REACH XVII) and comply with the requirements of the RoHS Directive (2011/65/EU, RoHS2 and 2015/863/EU, RoHS3)