



saunum

Saunum Automatic
Water Dispensing Unit **AutoLEIL**



THE BEST SAUNA EXPERIENCE TO HAVE!



I am very glad that you have invested in the Saunum device, and I believe that our innovative technology will offer you a wonderful and extraordinary sauna experience.

I have a degree in thermal engineering and come from Southern Estonia, where my love for saunas began. The special feature of local historic smoke saunas is the lower temperature and higher humidity level than, for example, a classic Finnish sauna. In ordinary saunas, the stone volume of the sauna heater is generally small. Such an arrangement can cause a sudden, burning hot steam and an extremely uneven temperature, where your head and shoulder level is really hot, but your feet are left cold. Such an experience can be quite unpleasant and may cause headaches and lead to body stress. However, in ancient smoke saunas and Native American saunas, the stones were first heated during the day. Then the heat stored in the stones was used to cleanse the body and create a truly enjoyable sauna experience.

Inspired by the experience of a smoke sauna, I wanted to create an innovative solution that combines the best features of an authentic sauna with modern technology; enabling a pleasantly mild and relaxing sauna experience without painfully scorching steam. For that, however, I had to solve the problem of how to achieve an even temperature, at both the head and foot levels. My development work was supported by research done alongside Tallinn University of Technology, in which we analysed the thermal stratification and air movement in the sauna room. Saunum was born in cooperation between scientific thinking and technological innovation.



Saunum's unique patented mixing system of air layers captures the hot steam that rises under the ceiling of the sauna room, mixes it with the cooler air from the surface of the floor, and directs the milder steam back evenly. This makes for an enjoyable, unaggressive heat. You can sit in the sauna for a longer time and enjoy a sweat and a deep cleanse without feeling tired. The stone volume of our heaters is significantly larger than other sauna heaters, which is the reason for the especially pleasant indoor climate with long and soft steam.

A moist steamy sauna, a therapeutic salt sauna, or a healthy aroma sauna – all of these functions are available on Saunum's devices to create a truly relaxing sauna experience. When using Himalayan salt orbs in our device, salt ions that are beneficial to the skin and respiratory tract evaporate and the steam circulates these into the air. Adding a sauna aroma system that blends steam and healthy aroma oil creates an even more enjoyable sauna environment.

Saunum's sauna devices are suitable for both adults and children.

Have a pleasant sauna!

Andrus Vare
The creator of Saunum



Saunum **congratulates you**
on choosing an innovative
sauna automatic water
dispensing unit!



CONTENTS

| | |
|---------------------------------------|---------|
| Warnings and notes _____ | 6 - 7 |
| Components _____ | 8 |
| General instructions _____ | 9 - 11 |
| Technical data _____ | 12 - 13 |
| Electrical connections _____ | 14 - 15 |
| INSTALLING | |
| Instructions for installation _____ | 16 |
| Installing the operating button _____ | 16 - 17 |
| Installing the humidity sensor _____ | 18 |
| Installing the main unit _____ | 19 |
| Installing the piping _____ | 20 |
| Installing the nozzle _____ | 21 |
| DIRECTION FOR USE | |
| Creating a sauna type _____ | 22 |
| AutoLEIL settings _____ | 22 |
| Automatic humidity _____ | 23 |
| Manual humidity _____ | 24 |
| Ready mode _____ | 24 |
| Automatic vent _____ | 25 |
| Sauna session _____ | 25 |
| Button _____ | 26 |
| Public sauna _____ | 26 - 27 |
| Warranty _____ | 28 |
| Installation Protocol _____ | 29 |



 **All users of this product must read the warnings and manual carefully before using the product!**

 **Failure to follow the instructions could result in personal injury, death, fire, and/or property damage, and the device's warranty may be voided.**

The automatic water dispensing unit is meant for the automatic dispensing of water on the heated stones of a sauna heater. Through its humidity sensor and electronics, the unit measures, creates, and maintains the sauna climate according to the user's preferences.

 **It is not to be used for any other purpose!**

This device should not be used by children, people with reduced mobility, or sick people. Children should use the device only under constant and close adult supervision.

Persons with reduced physical, sensory, or mental capabilities, or persons with a lack of experience and knowledge, should use this device only under constant and close adult supervision and only after consulting with a physician.

Before using the sauna, all users should consult with a physician to ensure that they have no health conditions that would make

sauna bathing unsafe and discuss time and temperature limitations.

Pregnant women should consult their physician before the use of the sauna. Excessive body temperatures have the potential to cause foetal damage during early pregnancy.

 The use of drugs, medication, or alcohol before or during the sauna session may lead to dizziness or unconsciousness, resulting in injury or death. No person should use this product while under the influence of alcohol or drugs.

 Persons taking medications should consult with their physician to ensure that it is safe to use sauna while taking their medications.

Users should place a towel between their skin and sauna bench or wall while sitting or lounging in the room. When using the sauna, be aware of the dangers associated with going to the sauna.

Do not stay in the sauna room for more than 30 minutes at a time!

Prolonged exposure to steam can be harmful or fatal. Users should discontinue using the sauna if they feel light-headed, dizzy, or experience heat exhaustion. It is prohibited to sleep inside the heated sauna. Users should take care to avoid falling asleep while using the sauna.



 **The electrical device should only be connected to the mains in accordance with all laws and regulations by a licensed, professional, certified electrician.**

 **After connecting and installing the control unit, the installer must inform the sauna owner or operator of all operating requirements.**

 **The requirements for use must be given by the owner or operator to everyone who uses the sauna.**

 **All maintenance other than regular surface cleaning of the product must be performed by a trained professional.**

Always disconnect the device from the mains before carrying out any maintenance work!

- Check the control unit for visible damage before installation and use. Do not use a damaged device or a device that has been modified from the original manufacturer's condition in any way.
- It is vital to install the device according to the instructions for installation and use. Failure to carefully follow all instructions can cause the risk of fire or short-circuit, leading to property damage bodily injury, or death.
- Accessories that the manufacturer has not approved should not be installed in this device. If suitable accessories are installed in the device, follow the accessory-specific operating and installation instructions!
- If the supply cord is damaged, it must be replaced by the manufacturers' service partner or a similarly qualified licensed, professional, certified electrician to avoid a hazard.
- Clean the control panel by using a lightly moistened cloth. Use only mild cleaning agents, never solvents or corrosive chemicals. Allow the product to dry thoroughly before operation.
- This product should not be disposed of with general household waste. When recycling your product, take it to your local collection facility or contact the place of purchase.



COMPONENTS

The Saunum water dispensing unit AutoLEIL consists of :

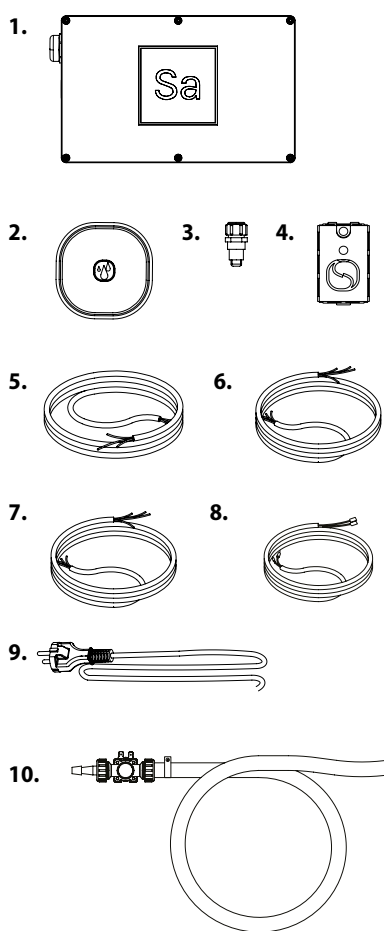

1. A control unit
2. An operating button
3. A spray nozzle
4. A humidity sensor
5. Communication cable from AutoLEIL to LEIL
6. Button cable
7. Humidity sensor cable
8. Water valve connection cable
9. Power cable
10. Water valve
11. Button drilling template
12. Set of screws (etc. LEIL box)

The control unit controls the supply of water to the heater.

The operating button is used to turn ON/OFF the automatic dispensing function and throw extra water on the heater stones.

The spray nozzle creates a wide-dispersed water spray pattern.

The humidity of the sauna room is regulated based on humidity sensor readings.



USING AUTOLEIL UNIT WITH LEIL CONTROL UNIT

NOTE! The device requires a Saunum LEIL controller for operation and is suitable with Saunum heaters.

NB! AutoLEIL requires the latest Saunum LEIL controller software.

Before proceeding, be sure to update the "Control Panel" on the LEIL touch screen.

AutoLEIL communicates with the Saunum LEIL controller via the data cable. LEIL is the main controller of the heater system, whereas AutoLEIL is an accessory device in the system.

AutoLEIL is recognised by LEIL when they are connected.

AutoLEIL does not have its own user interface – it uses the touch screen control panel of the LEIL system and the AutoLEIL functions will appear in LEIL system when the two systems are connected.

AutoLEIL is designed for the automatic dispensing of water on the heated stones of a sauna heater and scans and maintains sauna climate according to the user's preferences through the sensors and electronics of the unit. It allows the sauna user to sit back and relax, while the sauna humidity is regulated automatically.

Water dispensing parameters and sauna climate parameters can be modified through the LEIL touchscreen control panel.

- Controls the sauna room humidity according to humidity sensor readings.
- Throw user specified amounts of water at specified time intervals.
- The operating button inside the sauna allows throwing water on heated stones.

After completing the installation of the unit, the installer should give this manual to the owner of the sauna.

The product owner should provide the manual to all persons using or operating the sauna.

Please read more instructions for the installation, use, and recycling, in the original user manual of the control unit. Saunum reserves the right to modify this manual from time to time, and modifications will be posted to **www.saunum.com**.

Failure to follow the instructions could result in personal injury, death, fire, and/or property damage, and the device's warranty may be voided.



USING THE AUTOLEIL UNIT

The air in the sauna becomes dry as it heats up. Therefore, it is necessary to create steam to achieve a suitable level of humidity. The effects of heat and steam on people are different. When testing the different settings of the sauna climate device, you will find the most suitable combination of temperature and humidity. The effects of heat and steam on people are different.

- Always check there are no water leaks in the system.
 - Always check that the water dispensing unit has switched off and stopped water dispensing after the operation period has elapsed.
 - Always check that the water tap is closed when the sauna session is finished.
 - Make sure that the controller unit is installed in a dry room where the ambient temperature does not drop below 0°C to avoid the water in the system freezing.
 - Excessive moisture may damage the electrical equipment and sauna construction!
 - Make sure you have proper ventilation in the sauna room. Ventilate the sauna room after high-humidity sauna sessions.
 - Avoid throwing excessive amounts of water on the stones.
- Prolonged sauna use can damage your health or cause death.
 - Do not stay in the steam room for more than 30 continuous minutes (in a row).
 - Leave the steam room if you feel sleepy, dizzy, or weak.
 - Do not dry objects or living things in the sauna.



WATER DISPENSING IN PUBLIC SAUNAS

See also page 26-27!

By default, the AutoLEIL duration can be configured for up to 30 minutes.

In public saunas where the sauna is operating most of the day, this 30 minute duration is insufficient. In such cases, a manual switch needs to be made on LEIL "Power board" (inside the control box). **Not to be confused with AutoLEIL circuit board.**

NB! Make sure the device is disconnected from the main power before opening the control box!

VALVE OUTPUT

See also page 15 (Electrical connections)!

By default the AutoLEIL is provided with 12VDC water valve, connected on OUTPUT 1 of the circuit board.

It is possible to use instead 120 or 230 VAC water valve, connected to OUTPUT 3.

The red DIP switch has to be set accordingly:

Switch ON nr 1 if valve is 120 or 230VAC and connected to **OUTPUT 3**.

Switch OFF nr 1 if valve is 12VDC and connected to **OUTPUT 1**.

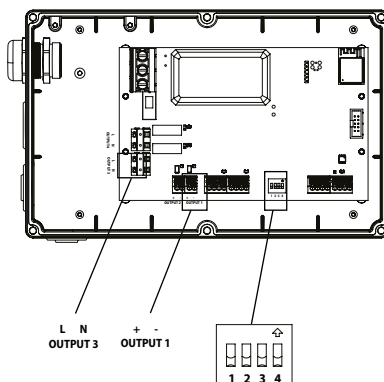



TECHNICAL DATA

CONTROL PANEL (LEIL TOUCH SCREEN):

- Humidity adjustment range 5–60% RH.
- Water output period adjustment range: 0.3–4 sec.
- Automatic water dispensing interval adjustment range 1–10 min.
- Automatic water dispensing function duration adjustment range: 1–30 min or 1–12 hrs settings.

AUTOLEIL MAIN UNIT:

- Supply voltage: 100-240VAC 1N~.
- Length of outlet hose 59 in. (1.5m)
- Dimensions: 2.36x10.11x6.49 in (60x257x165mm).

AUTOLEIL OPERATING BUTTON:

- Length of cable: 13.12 ft (4 m).
- Dimensions 1.18x1.96x0.78 in (72 × 72 × 15 mm).

AUTOLEIL HUMIDITY SENSOR:

- Length of cable: 13.12 ft (4 m).
- Dimensions 2.83x2.83x0.59 in (30x50 x20 mm).

ELECTRICAL CONNECTIONS

The connection of the main unit is shown on the diagram of electrical connections on **page 14-15**.

For more information on connecting the heater or LEIL control unit, see the respective heater and/or LEIL control unit installation and operating manuals.

If the connection and installation cables are located higher than 3.28 ft (100cm) from the floor of the sauna room or inside the walls of the sauna room, they must be able to withstand a temperature of at least 340°F (170°C) (e.g., SSJ).

Electrical equipment installed in the steam room below 3.28 ft (100cm) from the floor must withstand a temperature of at least 257°F (125 °C) (e.g., T125).

RECOMMENDED SIGNAL CABLE SIZES

NOTE! If it is necessary to extend the provided cables, use cables with similar technical specifications.

| | |
|---------------------|---|
| Operating Button | SiHF temperature-resistant cable, 4 x 24AWG (4 x 0.25 mm ²) |
| Humidity sensor | SiHF temperature-resistant cable, 4 x 24AWG (4 x 0.25 mm ²) |
| Communication cable | KLMA 3 x 0.8 + 0.8 HF |

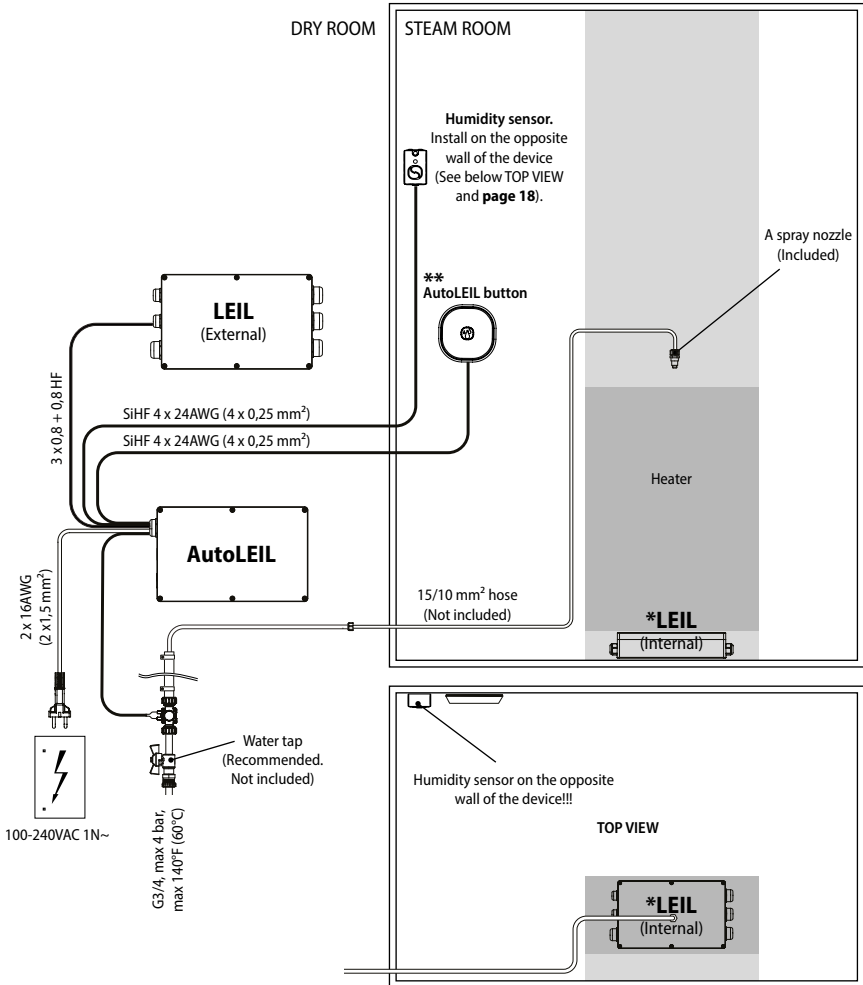

* Information on how to connect and access to the LEIL control unit, see the respective Saunum climate device and LEIL control unit installation and operating manuals.

** Possible to add up to 4 buttons.



LEIL automation

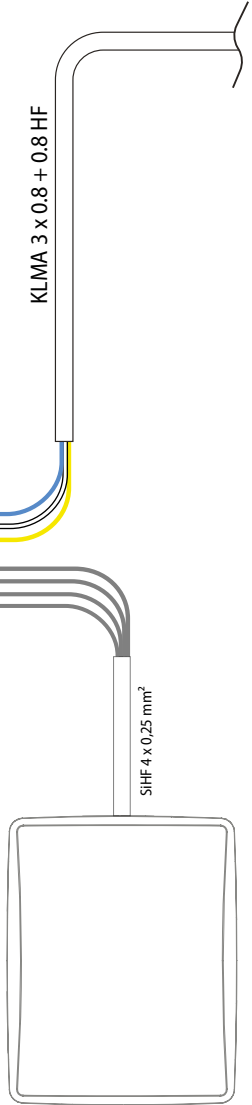
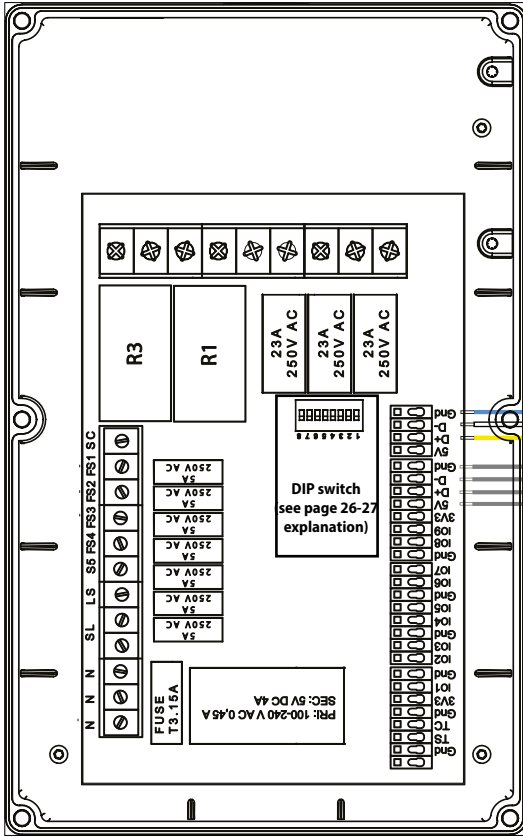

LEIL control panel
(read LEIL instruction
for use and installation manual)



INSTRUCTIONS FOR INSTALLATION

WARNING! Failure to install the product in accordance with all instructions herein will void the warranty. It can result in the risk of fire and/or electrical short-circuiting, leading to property damage, bodily injury, or death.

A licensed professional electrician may only do the installation of the control unit in accordance with current regulations. The person in charge of the installation should provide the necessary training and return the user manual to the product owner after completing the installation. The product owner should provide access to the manual to all persons using or operating the product.

INSTALLING THE OPERATING BUTTON

Install the operating button inside the sauna room. The button can be installed on the sauna wall or on the bench. Best to install it at least 11.81 in. (300mm) from the ceiling.

For concealed installation, the data cable can be installed in a protective tube inside the wall; if this is not possible, it must be installed on the wall surface.

1. Use the printed template to mark locations for screw holes and a drill hole 0.78-0.90 in. (\varnothing 20–23mm drill bit) for the cable connector.

If the cable is not concealed inside the wall, the hole can be only 0.19 in. (5mm) deep or carved into the wall using a sharp blade.

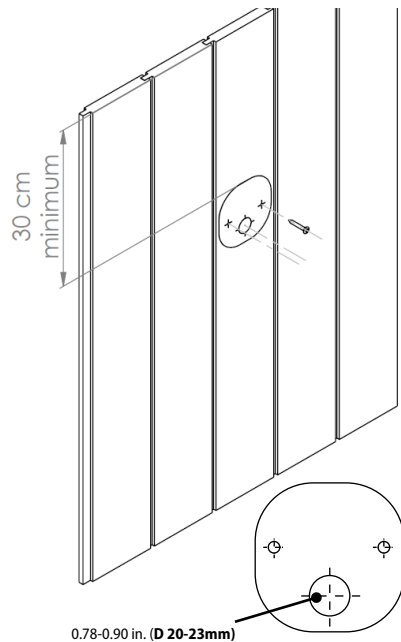

The operating button must be installed on the wall, in a place protected from water splashes.



2. Install the screws, leaving the heads out 0.11-0.15 in. (3-4mm) from the wall. Drill the hole through the wall and bring the cable to the opening. Pull enough cable through the hole to connect the cable to the button connectors.

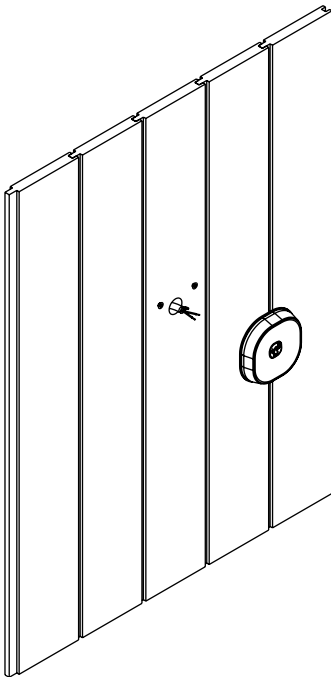

3. Connect the wires to the button connector. Make sure the wires are connected to the main unit in the same colour code order. See also the electrical schematic on **page 13**.

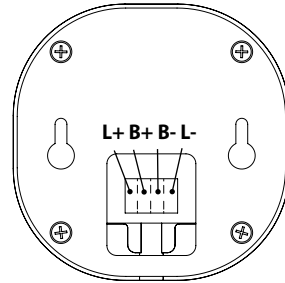

4. Connect the button to the wall, aligning screw heads with the keyholes in the back of the button.

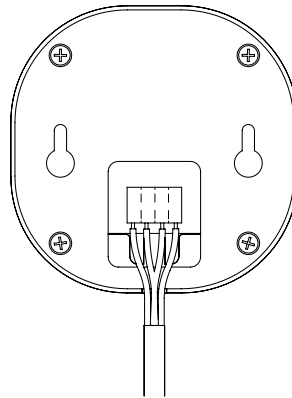

NOTE! If it's not possible to conceal the cable inside the wall, it can be installed on the wall surface. In this case, the wires must be pulled through the groove in the wooden enclosure before connecting to the connector.



INSTALLING THE HUMIDITY SENSOR

The humidity sensor must be located on the opposite wall of the Saunum climate device.

Do not install it behind objects that would restrict the air flow. For example behind the

bench support or similar. Otherwise the humidity readings will not be accurate.

The desired position is shown on below pictures.

Connect the sensor with 4 x 24AWG (4 x 0.25 mm²) humidity sensor data cable (see **page 12-13**).

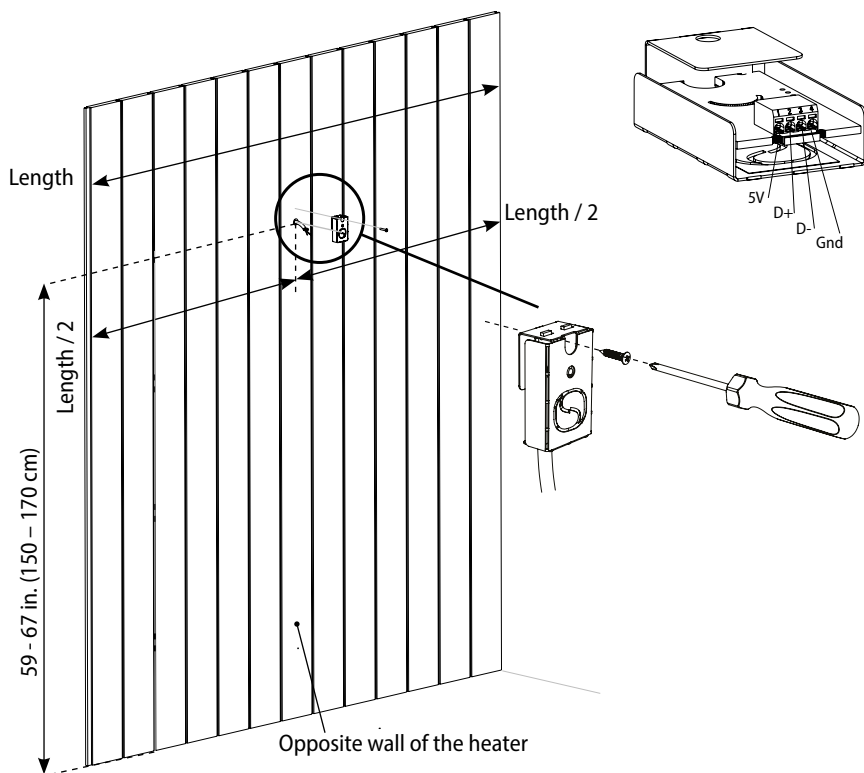



INSTALLING THE MAIN UNIT

The installation location for the main unit must be a dry space outside the sauna room with a floor drain (ambient temperature $>32F$ ($>0\text{ }^{\circ}\text{C}$) to avoid freezing of the water hose/pipes).

Fix the unit to the wall and make the electrical and water supply connections.

Make sure to install the water valve below the main unit box to avoid possibility of water leakage into the electronics.

As the AutoLEIL Main Unit needs to communicate with LEIL controller, it is advised that they are positioned close to each other (see **page 13**). The Main Unit communicates with LEIL via the provided data cable 4.92 in. (1.5 m), see **page 14-15** for further information about electrical connections.

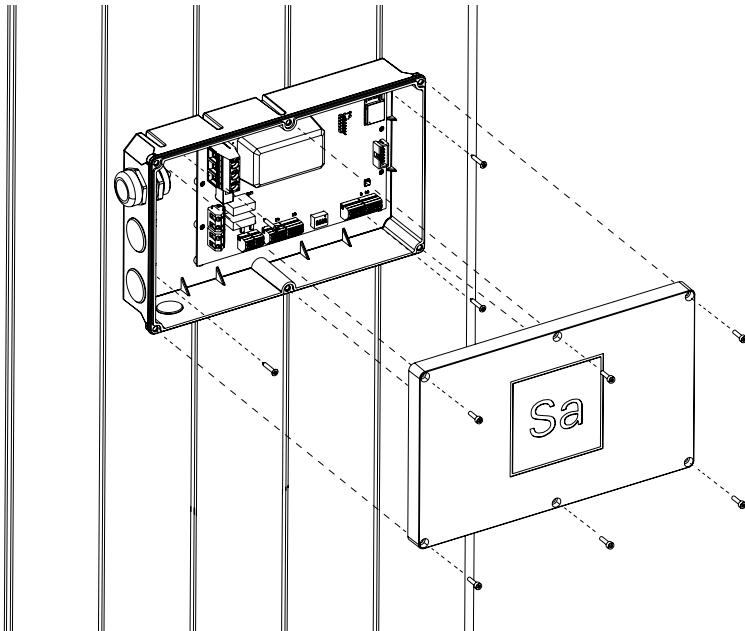



INSTALLING THE PIPING

Only the spray nozzle is included in the AutoLEIL package.

The other piping supplies are not included.

We recommend using a copper or stainless steel pipe (outer diameter 0.39 in. /10 mm) and metal fasteners.

NOTE! Piping must be heat resistant in the vicinity of the heater.

The pipe bending must be done on-site with a pipe bending tool.

The outlet of the water pipe must be centred 5.90-11.81 in. (150-300mm) above the stone basket stones.

See an installation example of the spray nozzle and piping in the figure below. We recommend using the spray nozzle delivered with the device.

Pre-bent stainless steel pipes for Saunum climate device are sold separately from the AutoLEIL package.

These pipes should be clamped onto the wall right next to the heater to save time during installation.

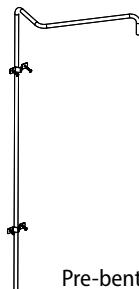

Pre-bent stainless steel pipe

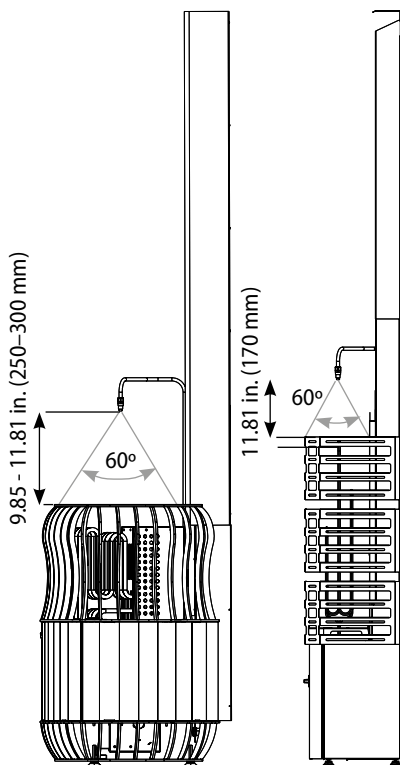



INSTALLING THE NOZZLE

When the pipe is installed, fit the spray nozzle in the end of water outlet pipe.

Cut the pipe square, deburr properly.

Slide cap nut (1) and compression ring (2) over tube end.

Push the fitting (3) against the pipe.

Push the nut (1) and ring (2) towards the fitting (3) and tighten by hand.

Make sure you keep pushing the fitting against the pipe the entire time.

Tighten the cap nut (1) with a wrench. The adequate number of turns for 3/8" (10mm) copper pipe is 1 full turn (360°) and for 3/8" (10mm) stainless steel pipe ¾ full turn (270°).

NOTE! Do not use a pipe-wrench!

Finally, tighten the spray nozzle (4) (external thread G¼) into the fitting (3).

After every water connection is made, pressurize the system and test for potential leaks.

Re-do or tighten the connections if necessary.

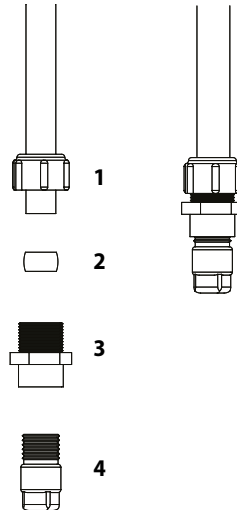



CONFIGURE A SAUNA TYPE

To start by configuring a personal pre-set sauna experience with LEIL control panel go to the main menu (**Fig.1**) - select **Types** and then **Sauna type 1-3**.

Rename them if it's needed (e.g. Sauna 75 (**Fig. 2**)).

Select **OK** - set the desired sauna session parameters (**Fig.3**): max. temperature, ventilator speed and duration, sauna session duration - select **OK**.

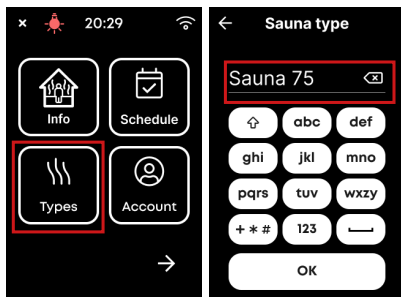

Figure 1

Figure 2



Figure 3

Your pre-set sauna type is saved.

AUTOLEIL

AutoLEIL settings will appear on the control panel **after** AutoLEIL is connected with LEIL power board (see page 14-15).



If AutoLeil does't appear, it may be necessary to reboot the The LEIL control panel!

Set up the automatic water dispensing mode – **Automatic - or Manual Humidity** (**Fig. 4 & 5**).

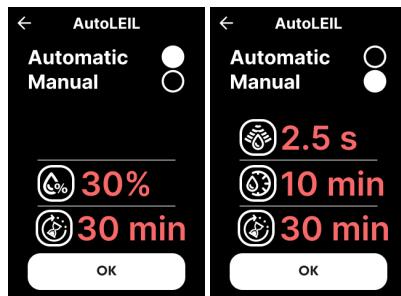

Figure 4

Figure 5



Automatic Humidity mode:



Relative humidity - define desired relative humidity (RH) between 5–60% (Fig.8) in the sauna room.



Duration - set the sauna session time between 1–30min (Fig.7).

AutoLeil automatically optimizes the water quantity and dispensing interval in order to reach the desired humidity level and maintain it throughout the session duration.

The maximum RH value that can be applied in Automatic Mode is correlated to the previously set temperature value. For example, it is not possible to set a more than 30% RH in a 158°F (70°C) sauna.

The approximate temperature/humidity limits are shown on the **Figure 8**.

Water is dispensed on the stones at intervals until the target humidity value is reached. Upon reaching the target humidity value, water is then dispensed when the humidity drops 5% below the target value.

As every sauna has unique ventilation, insulation, room size and layout, power of the heater, etc., the target value might not be possible to obtain or is reached at the expense of overly cooled stones.

Experimenting is necessary to determine the most optimal dispensing parameters.

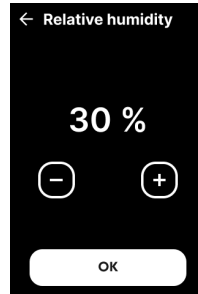

Figure 6

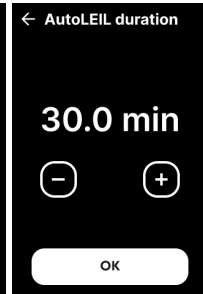

Figure 7

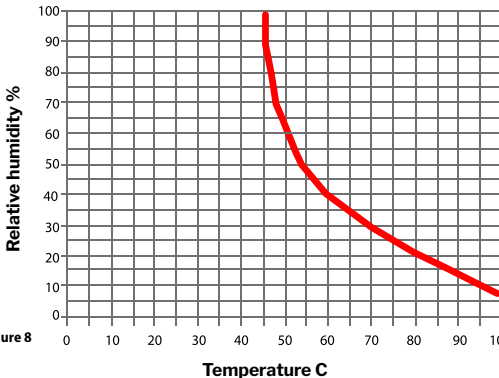

Figure 8



Manual humidity mode:



Water quantity - allows the user to define the water quantity from 0.3–4 sec (Fig.11).



Time interval - allows the user to set the time interval from 1–10 min of the water dispensing (Fig.12).



Duration - set the sauna session time between 1–30min (Fig.9).

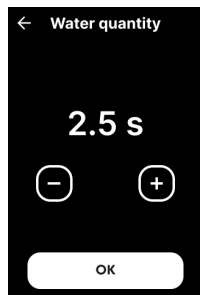

Figure 11

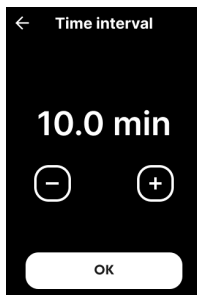

Figure 12

The exact amount of water dispensed depends on the water tap pressure. Please note that, in most cases, with good water pressure a 2–4 second value for water quantity can be an excessive amount of water.

We recommend to start testing with 0.5–0.8 seconds to get a feel.

SETTINGS MENU

An additional "AutoLEIL" option is now available from the settings menu of the touchscreen (Fig.13).

It has 2 options: Ready mode & Automatic vent (Fig.14).

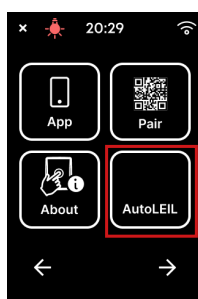

Figure 13

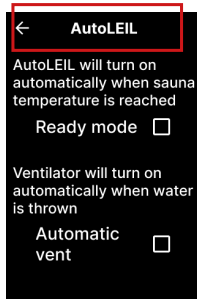

Figure 14

Ready mode - the AutoLEIL will switch on automatically as soon as the sauna reaches the target temperature and displays "Ready" (Fig.15).

This option is useful to be sure that the sauna environment is perfect when you get inside.

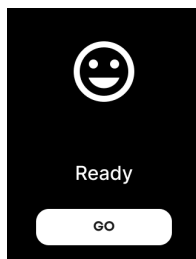

Figure 15



Automatic vent - the heater re-circulation fan will turn on when water is dispensed by the AutoLEIL valve.

The duration of the fan is the same duration set in the sauna type (**Page 22, Fig. 3**). This is useful when the re-circulation fan is not always in use during the sauna session and you want to make sure to use the full feature of the Saunum heater.

SAUNA SESSION

When you are ready to have a sauna, select the pre-set sauna type (etc. Sauna 75) from the main selection screen (**Fig. 17**). The last row displays the AutoLEIL settings (**Fig. 18**) and can be changed by selecting it (**Fig. 19**).

Once the sauna is ready (**Fig. 15**), the screen has AutoLEIL control on the last row (**Fig. 20, A**).

Pressing on the AutoLEIL humidity value will bring the same settings page than previously (**Fig. 19**).

The AutoLEIL session can be switched on/off by pressing on the power button icon in the AutoLEIL row.

When the session is ON, the icon on last row (**Fig. 20, A**) is blinking.

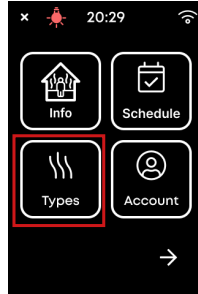

Figure 16

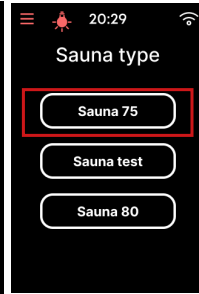

Figure 17

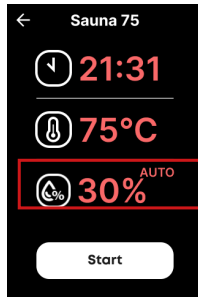

Figure 18

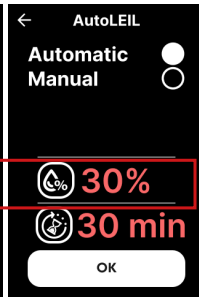

Figure 19

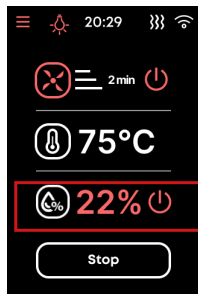
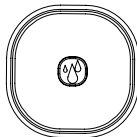

Figure 20



BUTTON



The button is intended for turning the AutoLeil session ON or OFF, as well as manually dispensing additional splashes of water on the rocks.

ON/OFF - press the operating button (~3sec) to switch the AutoLeil session ON/OFF.

LED light indicates whether the dispensing is ON (light ON) or OFF (light OFF).



It is recommended to turn OFF automatic water dispensing when leaving sauna room, this will avoid excessive cooling of the rocks.

Water - by pushing the operating button (while ON), the device dispenses a pre-set amount (**Page 24, Fig.11**, "Water quantity") of water on the heater stones.

The LED will be blinking slowing 3 times to acknowledge the valve opening.

When water is dispensed automatically (**Page 24** pre-set options), the LED on the button will be blinking slowly 3 times to acknowledge the valve opening.

If case you push the button and the AutoLeil session is OFF, the LED will do a fast-blinking pattern to indicate that water

will not be dispensed.

Same applies if you try to manually dispense water at too close intervals. Right now, there is a 10 sec cooldown period between 2 water dispensing. If you press the button while still in this cooldown period, the LED will also be doing a fast-blinking pattern.

PUBLIC SAUNA

By default, the AutoLEIL duration can be configured for up to 30 minutes. In such cases, a manual switch needs to be made on Leil "Power board" (inside the control box). **Not to be confused with AutoLEIL circuit board.**

- Open the cover on the **LEIL** controller (secured with 6 screws).
- On the circuit board the red dip switch nr.

LEIL automation

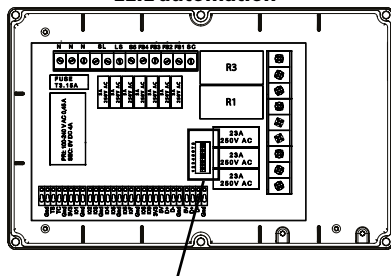

Switch **ON** nr 2

Figure 20



2 to the ON position (Fig.20).

After making that switch, the settings are changed in AutoLEIL duration setting.

Now the duration can be set from 1 hour to up to 12 hours, in 1-hour increments.

! After making the switch, only Public Sauna mode is available in AutoLEIL settings (Fig.21).

We recommend configuring the water dispensing to a small water quantity and adequate water dispensing intervals to avoid cooling the stones, for example a 0.5 sec (Fig.21 A) water splash at 3-to-5-

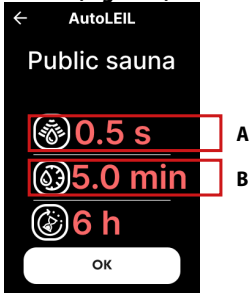

Figure 21

minute intervals (Fig.21 B).

We also recommend activating the “Automatic Vent” function from the AutoLEIL options (Fig.22 & 23).

In public sauna mode we recommend the ventilator duration and water dispense interval are in more or less 50/50 correlation.

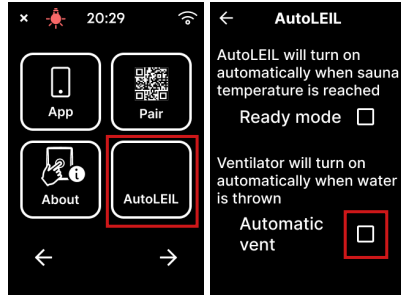

Figure 22

Figure 23

For example, if the watering interval is set to 5 minutes, the ventilator timing should be set to 2-3 minutes.

NB! Experimenting is necessary to determine most optimal dispensing parameters!

! Please note that in Public Sauna mode the humidity sensor functionality is limited to only reading the relative humidity value.

Default settings can be restored **ONLY** if the red dip switch on the LEIL power board is returned to its original position (Fig.24).

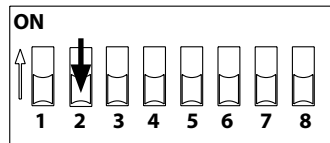

Switch OFF nr 2

Figure 24



WARRANTY

With the Saunum device warranty, Saunum guarantees that the product will be free from defects in the materials and the assembly for a specified period after the date of purchase. If, during the warranty period, the device is found to be defective due to the use of substandard materials or the quality of the assembly, Saunum's recommended repair partners will repair or replace the device or its defective part under the conditions set out below. Saunum reserves the right to decide whether to replace the defective product component or to replace the device with a new one. The replaced defective product components remain the property of Saunum.

Warranty conditions:

1. The warranty is only valid if a completed installation report is submitted with the claim.
2. The device has been connected to the power network by a qualified electrician in accordance with the regulations in force.
3. The warranty period of the sauna climate device when used in a private sauna is two (2) years.

Not covered by the warranty:

1. Routine maintenance and cleaning of the device and replacement of the components due to normal wear and tear.
2. Adaptation or modification of the device for any purpose other than that indicated in the instructions for use.
3. Risks arising from transport.
4. Damage resulting from the misuse of the device.
5. Damage resulting from the improper installation of the device;
6. Repairs to the device not carried out by Saunum's recommended repair partner (maintenance partner).
7. Accidents, lightning, water, fire, improper ventilation, or any other factor beyond the control of Saunum.
8. Breakages caused by the use of stones and salt balls not recommended by Saunum.
9. The heating elements and the salt balls.
10. Saunum will not cover labour cost.

For installation and maintenance help contact with your local distributor.

techsupport@bathingbrands.com
phone: +1 (224) 253-5909



INSTALLATION **REPORT**

Date of purchase: _____

Heater type: _____

Date of installation: _____

Place of installation: _____

Installed by: _____

Checked by: _____

Date, signature: _____

Description of the work done: _____

All the details are available for the installation _____

There are no colour defects or dents _____

Installed on the wall or on the floor according to the instructions _____

The electrical connections are made according to the installation instructions _____

All the heating elements heat up _____

The three fan speeds are working / in the correct order _____

Notes: _____

Customer's contact (name, email address): _____

Received work: _____

Warranty start date: _____

Read all of the instructions for use carefully and thoroughly before using the device and keep them in a safe and easily accessible place for future reference.

ENG

INSTRUCTION FOR USE AND INSTALLATION