



INSTALLATION GUIDE AND USER MANUAL OF  
SAUNUM AIRCUBE SPACE

saunum

## Contents

1. Installation requirements .....	3
2. Transport.....	4
3. Protective OSB box disassembling .....	5
Disassembling steps:.....	5
4. Final assembly .....	7
Needed tools for the assembly .....	7
Included assembly materials.....	7
Final Assembly Instructions: .....	8
5. Instructions for adjusting sauna door .....	11
Adjusting the hinge .....	11
6. Sauna electrical connections .....	12
7. User guide .....	16
Using and connecting Bluetooth speakers .....	16
Using remote controller.....	16
8. Maintenance .....	17
General upkeep.....	17
Interior maintenance .....	17
Exterior care.....	17
General notes.....	17
9. WARRANTY CONDITIONS FOR SAUNUM SAUNAS.....	18
Warranty Period:.....	18
Coverage: .....	18
Exclusions:.....	19
Claims Process:.....	19
10. Spare parts .....	20

# saunum

Thank you for purchasing a Saunum outdoor sauna!

## 1. Installation requirements

The base or foundation for Sauna must be **leveled** and **stable**. Sauna must be at least 3 inches higher from the surrounding ground. All base beams must have a support under them.

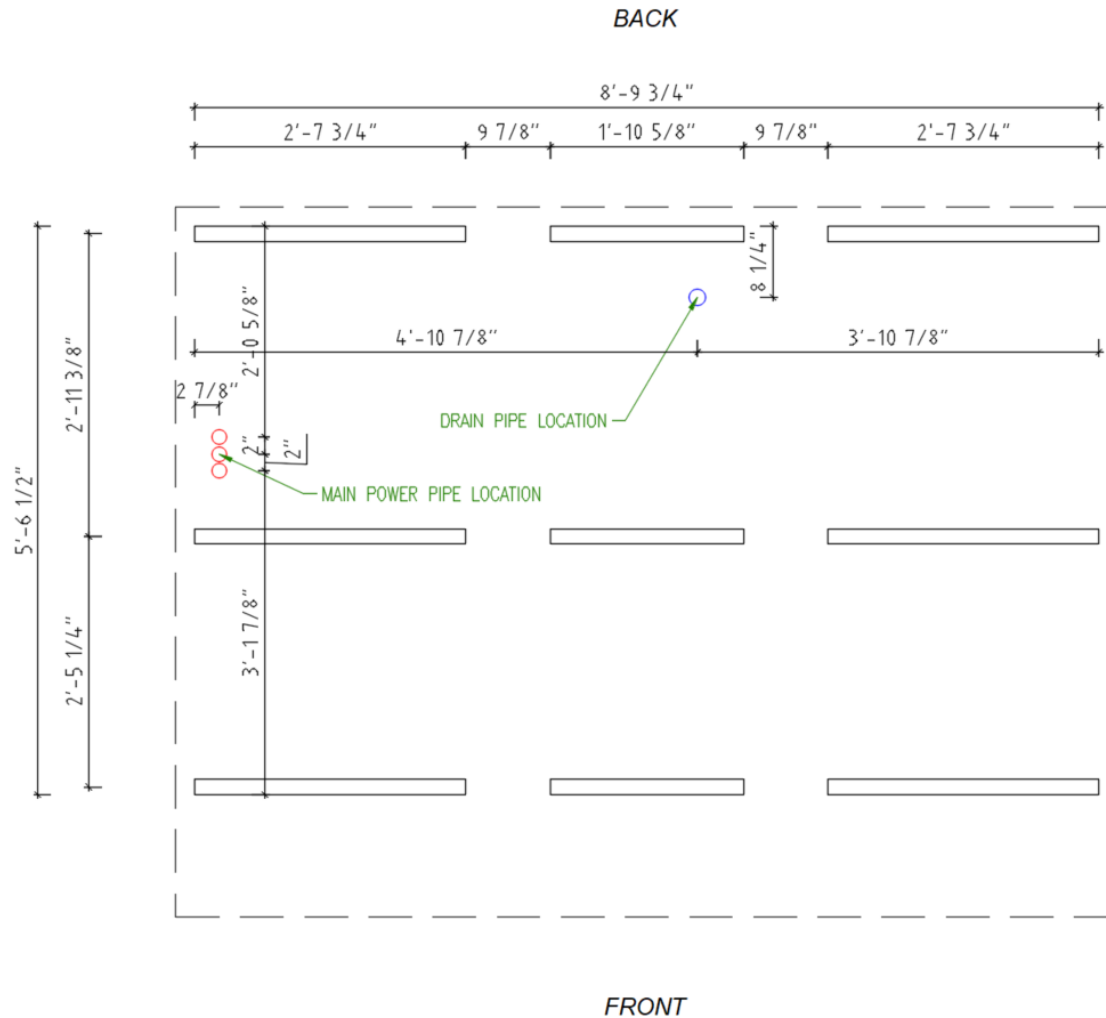

### **Recommendation:**

*We recommend placing Sauna on concrete blocks or strips that have a compressed gravel underneath. Using geotextile under the Sauna prevents the growth of grass and weed.*

*It is also possible to place the Sauna on terrace or pavement, but the Sauna should still be higher than the surface.*

# saunum

## 2. Transport

Sauna is packed into protective OSB box. Do not disassemble the box before the sauna is in the final location.

Sauna can be lifted from above with crane:

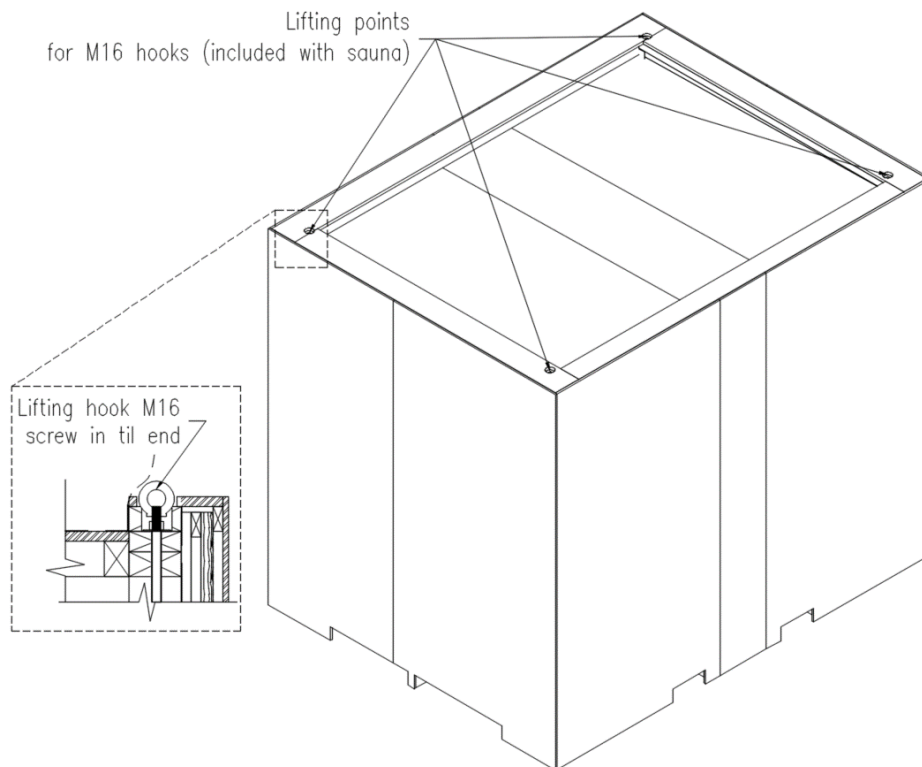

Sauna can be lifted from **below** with forklift:

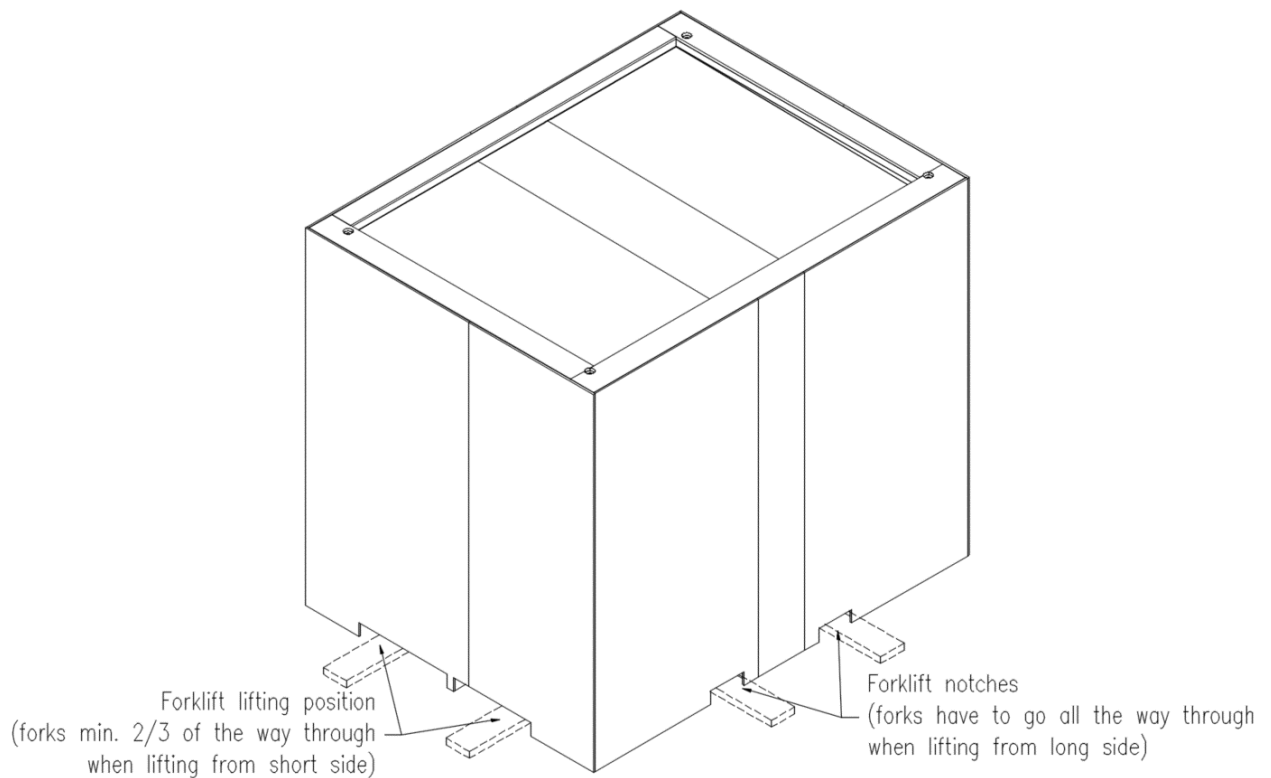

## 3. Protective OSB box disassembling

Dismantle the protective OSB box before final assembly. OSB boards are fastened with small screws covered with round stickers. The OSB boards, including the screw cover stickers, are painted black. The stickers prevent paint from getting into the screw heads and the screws are much easier to find.

### Disassembling steps:

1. Remove stickers from the boards
2. Unscrew the boards with a power screwdriver
3. Remove the OSB boards and stack them on a level surface
4. Make sure that the supports of the boards do not come loose and fall down when loosening the screws

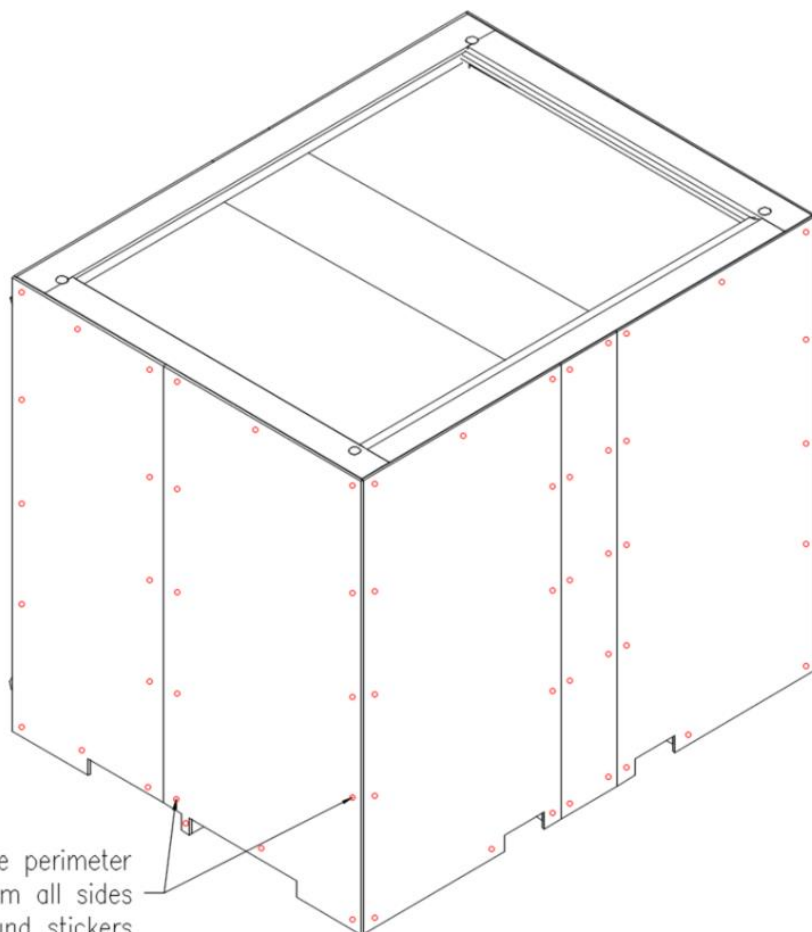

# saunum

---

5. Once all the boards around the sauna have been removed, you can start dismantling the board supports at the top and bottom of the sauna
6. At the top are OSB strips with battens that are attached to the top with screws
7. The lower part of the boards is supported with timber. These are fastened with longer screws
8. Board supports taken off; the final assembly process can be started.

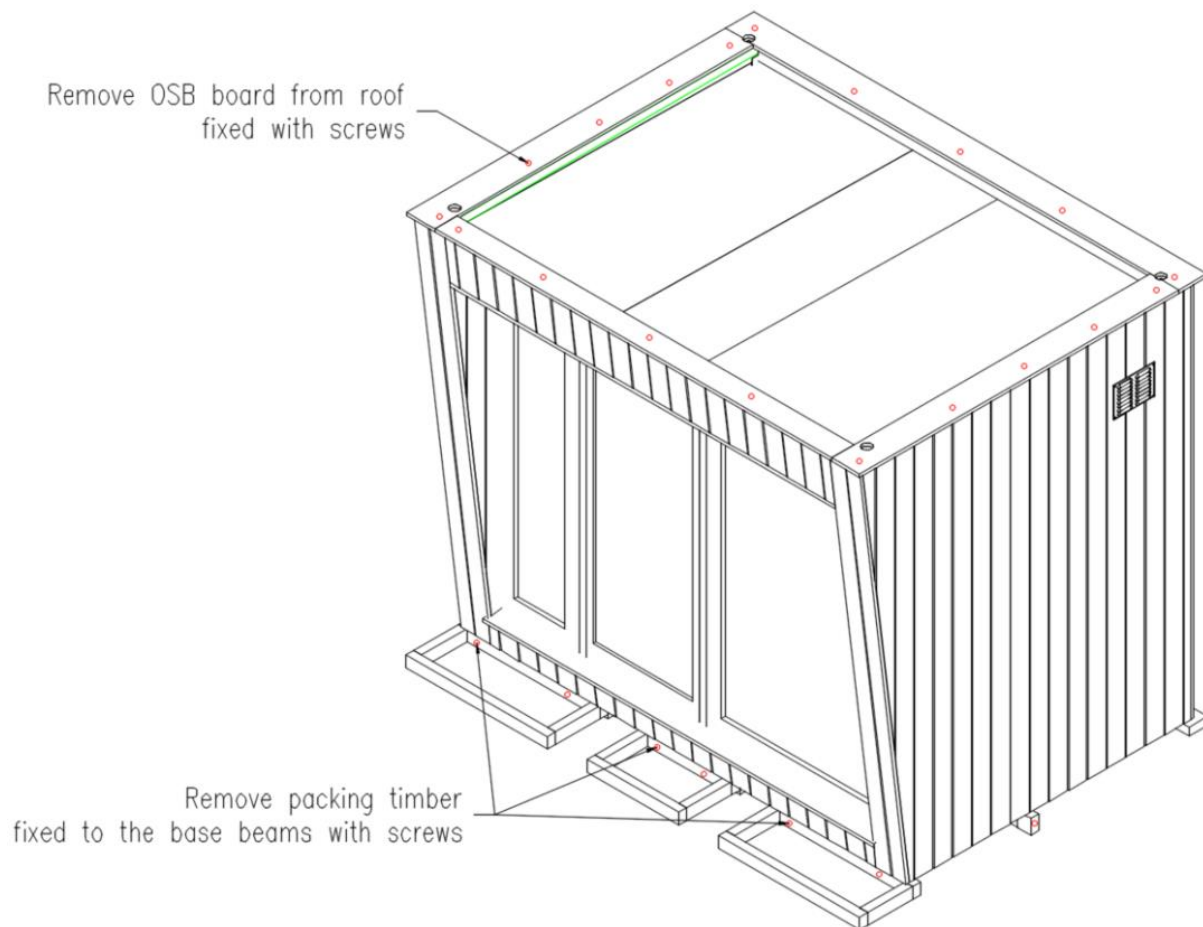

## PS!

1. Be aware of the risk of falling objects when unpacking the package
2. Screw markings on drawings are indicative
3. Dispose of packaging material according to local requirements

## 4. Final assembly

Final assembly shall be organized **by the client**. All electrical connections must be made by certified electrician.

Final assembly includes installing of the:

- Parapet metal;
- Decorative base boards;
- Rainwater system;
- Main power cable;
- Heater (*+ control unit*);
- Outdoor 12V lights.

Sauna door must be adjusted according to the instructions after the final installation, if needed.

### Needed tools for the assembly

- Ladder
- Leveler
- Tape measure
- Drill Driver
- TORX head driver bit set
- 8 mm hex head socket for the driver
- Sheet metal scissors
- Metal cutting saw
- 3,2 mm drill bit for metal
- River gun
- Pliers
- Hex key set
- Screwdriver set
- Sealant gun,
- Paint brush
- Circular saw

### Included assembly materials

#### Fixings:

4,8x28; 8mm HEX screws, black  
4x50; TX20 woodscrews, black  
5x70; TX25 woodscrews  
3,2x8 rivet, black, alu.

#### Electrical:

Exterior light, 2 pcs.  
Light bulbs, GU10, 12V, 4 pcs.

#### Exterior finish:

Extra cladding boards, 2 pcs.  
Base boards, 4 pcs.  
Repair paint, 400 ml

#### Rainwater system:

Gutter  
Gutter support bracket, 4 pcs.  
Drop outlet  
Downpipe  
Downpipe brackets, 2 pcs.  
Outlet  
Parapet metal front  
Parapet metal right  
Parapet metal left

# saunum

## Final Assembly Instructions:

Sauna cannot be exposed to the weather conditions without parapet metals

### Parapet metals installation.

1. Unwrap metals carefully, do not scratch paint surface with sharp objects
2. Place the metal on the parapet. The longer piece is for the front and the shorter ones are for the left and right sides.
3. Ensure that the metals are aligned in the corners so that there are no gaps between them. Use metal scissors to adjust, if needed.
4. Use black weather resistant sealant between two sheets and fix both corners with two rivets
5. Corners fixed, then rest of the metals need to be fastened to the parapet. Secure metals from the top using 4,8x28 Hex screws. Use a zigzag pattern for fastening with a spacing of 300 mm between each fastener.

### Exterior lights installation.

All electrical connections must be made by certified electrician.

1. Cut cable to the correct length that you will need for installing
2. Insert cable to the light terminal block and faster firmly
3. Use woodscrews to fix lights on the wall
4. Insert light bulbs, two for each light
5. Put the light fixture covers in place and fasten them

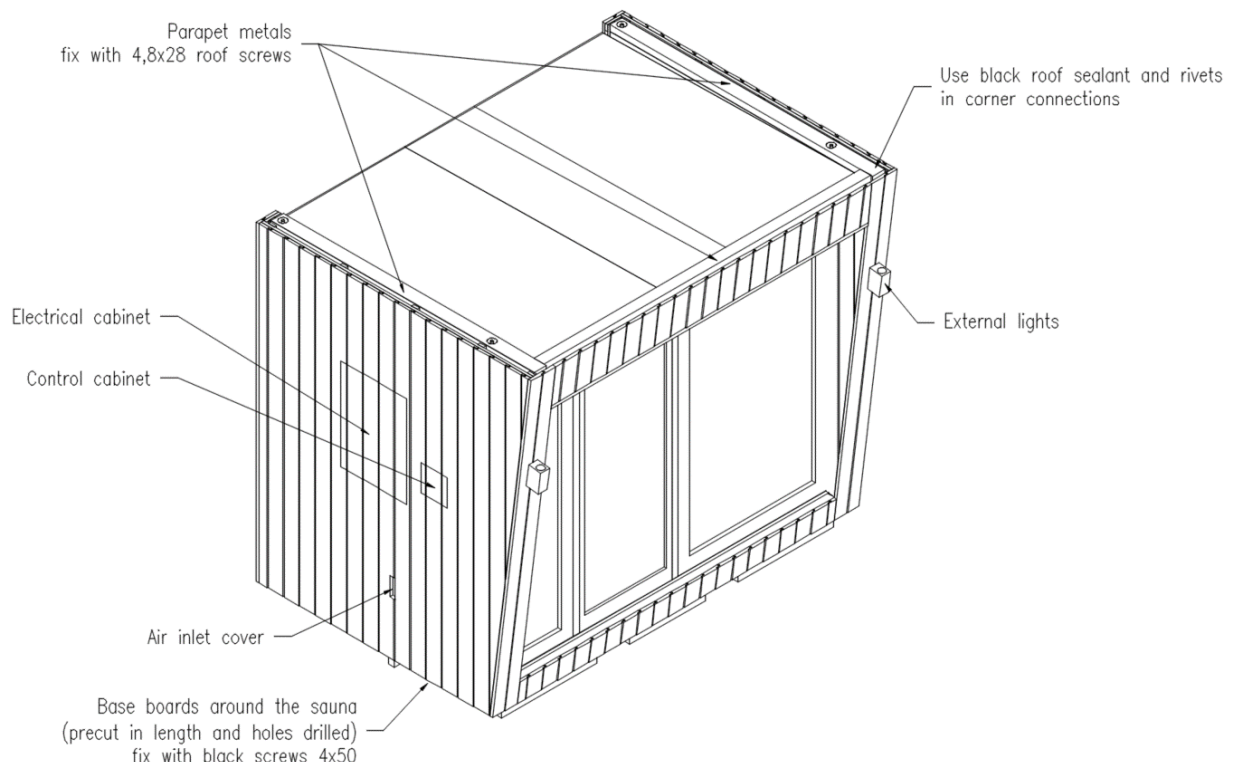



# saunum

## Rainwater system installation

1. Begin the assembly process by securing gutter brackets to the wall using 5x70 woodscrews, with 2 screws per bracket. Distribute the gaps equally between the five brackets along the length of the gutter.
2. The brackets should be mounted with a slight downward angle towards the drain outlet
3. Mark the location on the underside of the gutter where you want to attach the downpipe. Using a hacksaw, make an opening in the base of the gutter

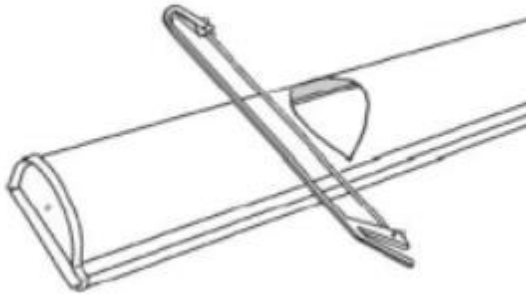

4. Position the gutter on the brackets and push it down until it clicks into place.
5. Place the drop outlet from below over the hole cut in the gutter. Bend the strips of the outlet around the edges of the gutter so the end piece is firmly in place. Use Pliers if necessary

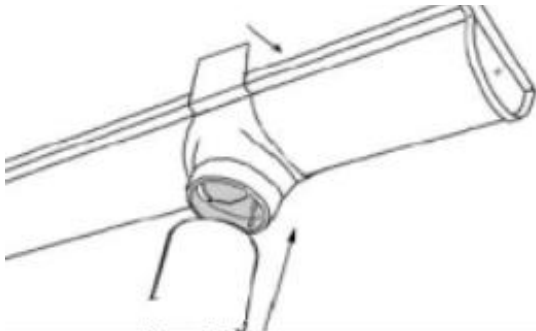

6. Install downpipe brackets use 5x70 screws two or each on the centerline of the drop outlet. Use 5x70 screws two or each. Brackets are required on both ends of the downpipe - at the connection with the drop outlet and at the elbow outlet.

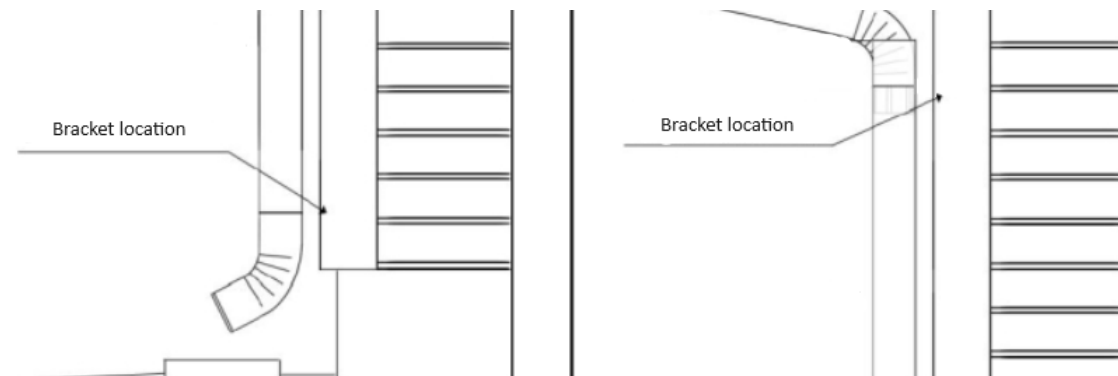

# saunum

7. Insert the downpipe into drop outlet and fasten the pipe on the wall with brackets

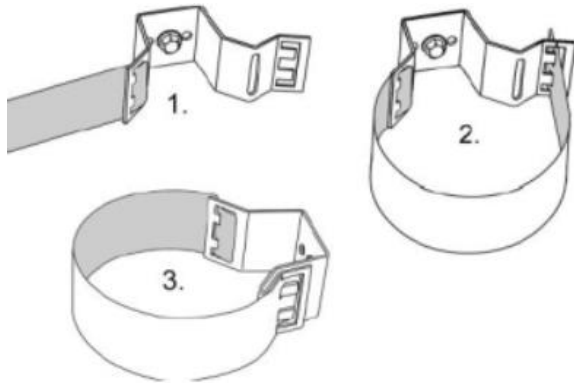

8. Finally use rivets to attach the pipe ends to the outlets.

## Base boards installation

Purpose of the base boards is decorative. Baseboards have been cut in the correct length and have pre-drilled holes in them. When installing the baseboards, make sure you are using the right board on the correct side. Attach each baseboard to the base beams using 4x50mm (black) woodscrews.

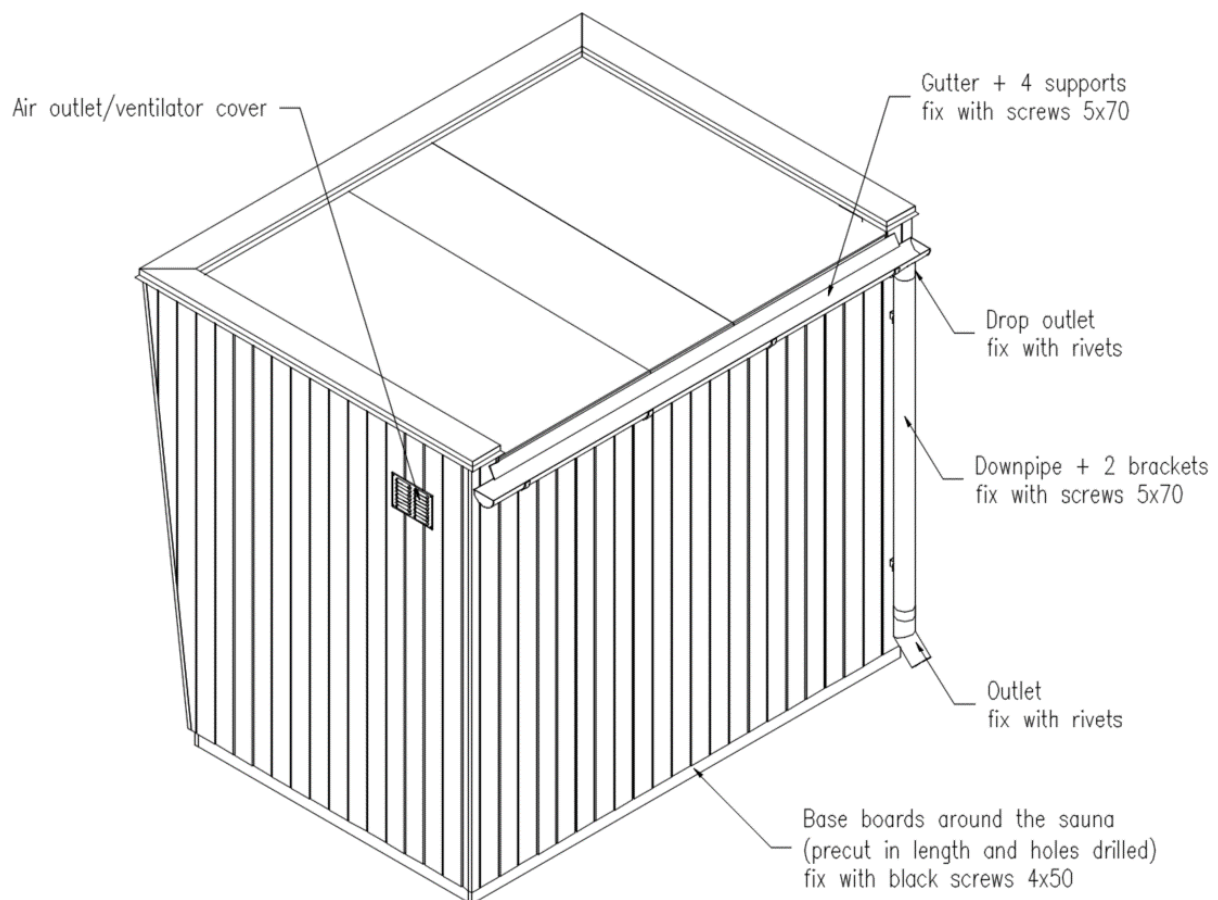

## 5. Instructions for adjusting sauna door

### Adjusting the hinge

The door hinge N3248-110 TMKSS use allows for vertical and horizontal adjustment.

**Door leaf adjustment up/down, see Figure 3.**

Remove the protective cap 1 from one door hinge (using a 5mm Allen key).

By turning the Allen bolt 2 below it clockwise (using a 5mm Allen key). The door leaf moves upwards (one full turn raises door leaf by 1 mm); turning it counter clockwise, the door leaf moves downwards. After the door leaf has risen to the desired height, adjust the other hinges in the same way so that the weight of the door leaf is evenly distributed between the hinges. Slightly tighten the upper protective cap 1.

**Adjusting the door leaf's side gaps inside the frame, see Figure 3**

Open the door leaf so that you can easily access the frame-side fastening screws of the hinges. Loosen the middle hinge's fastening screws 3 by approx. 1,5 turns, using TX25 screwdriver. Turn the adjusting bolts 4 clockwise (using a 4mm Allen key) to increase the door leaf's gap inside the frame on the hinge side (one full turn moves the door leaf by approx. 2 mm). Tighten the adjusting bolts 4 all to the same depth; carefully tighten the fastening screws 3. If necessary, make the same adjustments at the upper hinge. It is important that the axis of the middle hinge be in line with the axis of the upper and lower hinges. Finally, retighten the fastening screws 3 of all hinges.

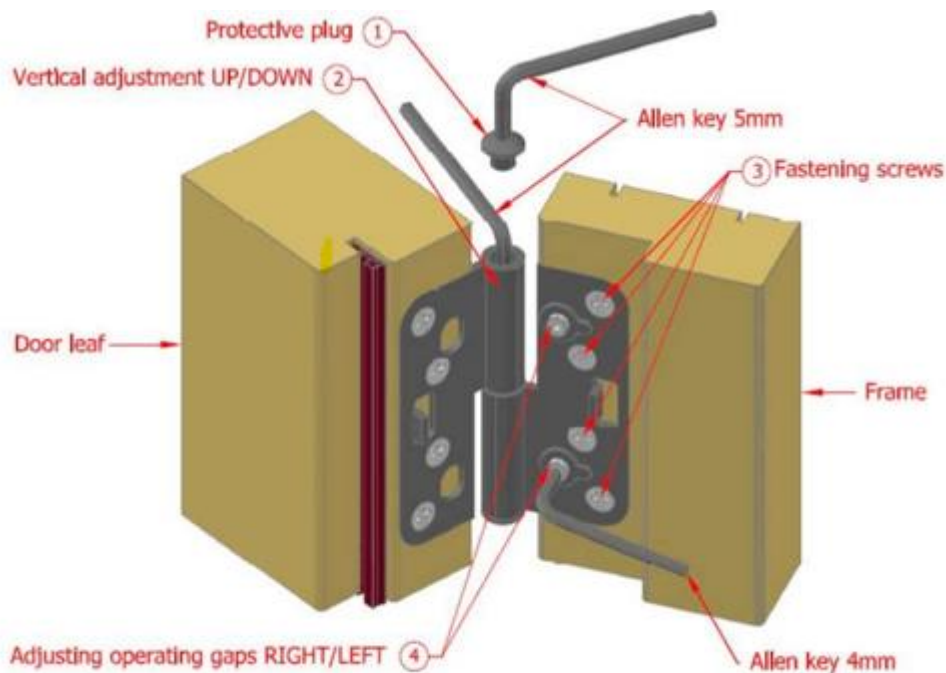

Figure 3. Adjusting the hinges

**Remember:** Adjusting the hinges corrects the position of the door leaf in relation to the frame (gaps); it is not possible to eliminate the warp of incorrectly installed frames. Regular lubrication of the door hinges twice a year improves their performance and prolongs their service life.

## 6. Sauna electrical connections

Saunas have been prewired. All electrical connections for LED lights, speakers and ventilator are made in factory (**Figure 1**).

**All the electrical connections must be made by certified electrician.**

### Electrical connections

1. There are two electrical boxes (120 VAC ja 240 VAC) located behind wooden door on the side of the sauna. Door can be unlocked with the small key, that is provided with the sauna
2. The top electrical panel 120 VAC is for LED lights and lower one 240 VAC for heater control unit + ventilator. The access doors to the electrical boxes can be opened using a flat head screwdriver.
3. To get to the electrical connections, you need to unscrew the metal covers using a TX20 screwdriver.
4. After you have removed metal covers, you will find distribution terminal blocks, where power supply cables must be connected (**Figure 1, Nr.8**) Powering lights/vent 120V max. 1kW/9A, wires three 16AWG, 600V and for powering heater 240V max. 11kW/46A, four wires 10AWG, 600V. All cables must be external use only.
5. Underneath the sauna, there are three conduit pipes, which are intended to run through power cables for sauna.
6. Cables will enter 240 VAC box through holes in bottom of electrical cabinet (**Figure 2, POWER**). Cabel in 120 VAC box will enter through the side of the cabinet (**Figure 2, POWER**).
7. Wires must be connected to distribution terminal blocks and tightened with the screws. (**Figure 2, Nr.8**)

240 VAC box:	120 VAC box:
<ul style="list-style-type: none"><li>• L1 – 120 VAC live wire</li><li>• L2 – 120 VAC live wire</li><li>• N – neutral wire</li><li>• PE – ground wire</li></ul>	<ul style="list-style-type: none"><li>• L1 – 120 VAC live wire</li><li>• N – neutral wire</li><li>• PE – ground wire</li></ul>
8. 240 VAC electrical cabinet has free space for mounting heater control unit box (**Figure 2, Heater Control Box**). All cables, that need to be connected to control unit are labeled (Heater power, Heater vent, Temp. sensor, Controller, Door sensor). Heater manufacture installation manuals must be followed.
9. Preparations have been made for controller installations inside the sauna. String has been threaded through conduit leading to a 120VAC electrical box (**Figure 2, Controller**). The string and controller cable need to be tied together so that the cable can be pulled through to replace the string. Follow the manufacture installation manual to choose correct cable.
10. Door sensor cable (2x0,75) is preplaced trough door threshold. While mounting heater, the door sensor must be installed. Door sensor must be flush with the door threshold and the magnet need to be glued underneath the door frame.

# saunum

11. Inside the wall is rigid pipe, which leads to the 120 VAC electrical box. To install temperature sensor, hole needs to be thrilled through heater side of the wall. Thrilled hole must be at least 2 inches deep, but not more than 3 inches. Location of the hole is **shown on the drawing below**. Measurement must be taken from the window frame and the ceiling. After the hole is thrilled, suitable cable must be pulled through hole and pipe. Follow heater manufacture installation manuals

Pipe location in the wall for temperature sensor  
height 2-10 inches from ceiling  
Client can drill the hole in the appropriate height  
and rurd the wire through

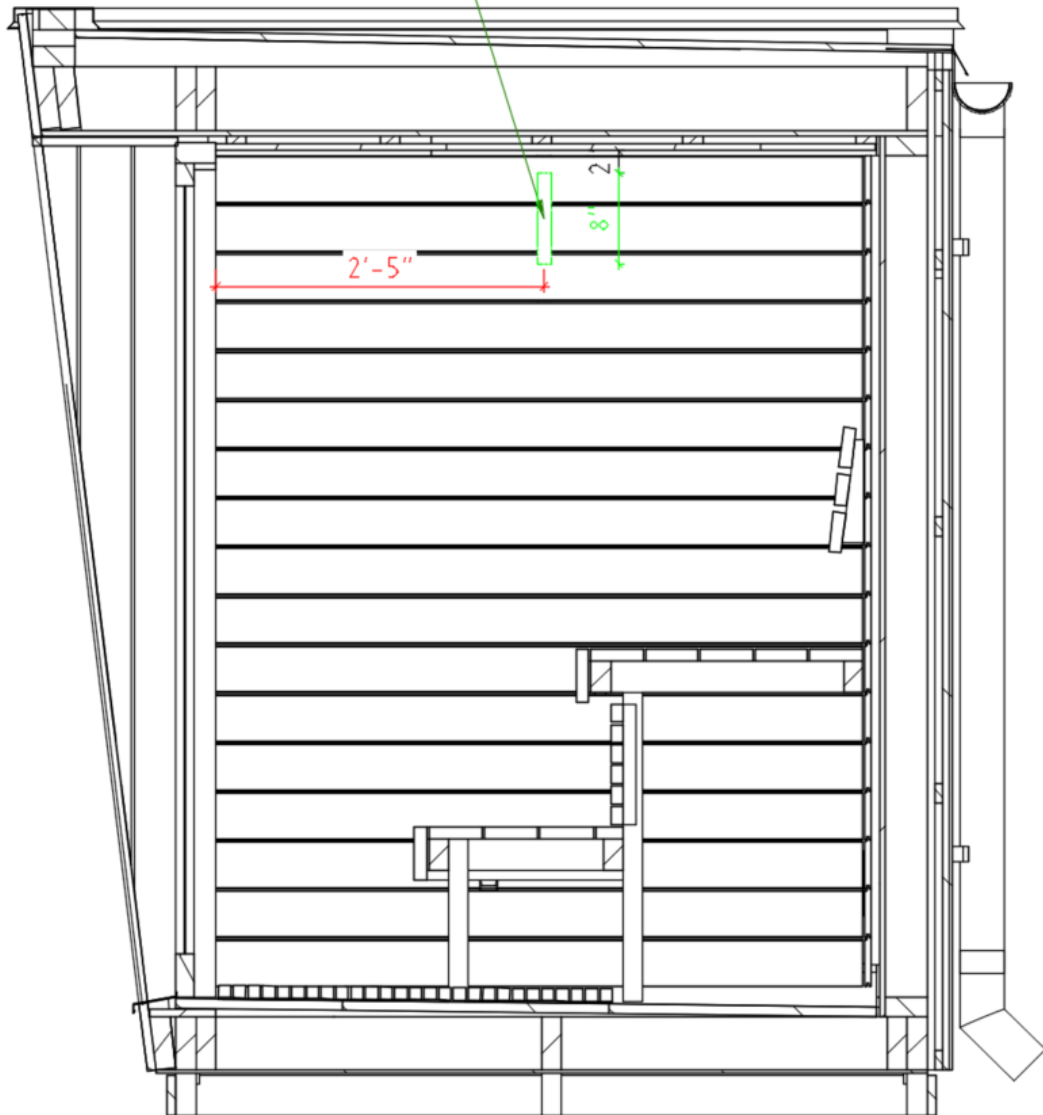

PART SPECIFICATION		
NUMBER	MANUFACTURER CODE	ORDER NR
1	WAGO 2002-1201	9050023
2	WAGO 2002-1204	9050025
3	WAGO 2002-1291	9050043
4	WAGO 2004-1201	9050059
5	WAGO 2004-1204	9050060
6	WAGO 2004-1291	9050061
7	WAGO 2004-402	9050063
8	WAGO 284-621	9050075
9	WAGO 788-311	9050074
10	WAGO 249-116	9050062

Figure 1.  
SAUNUM AIRCUBE SPACE  
CONNECTIONS DONE IN FACTORY

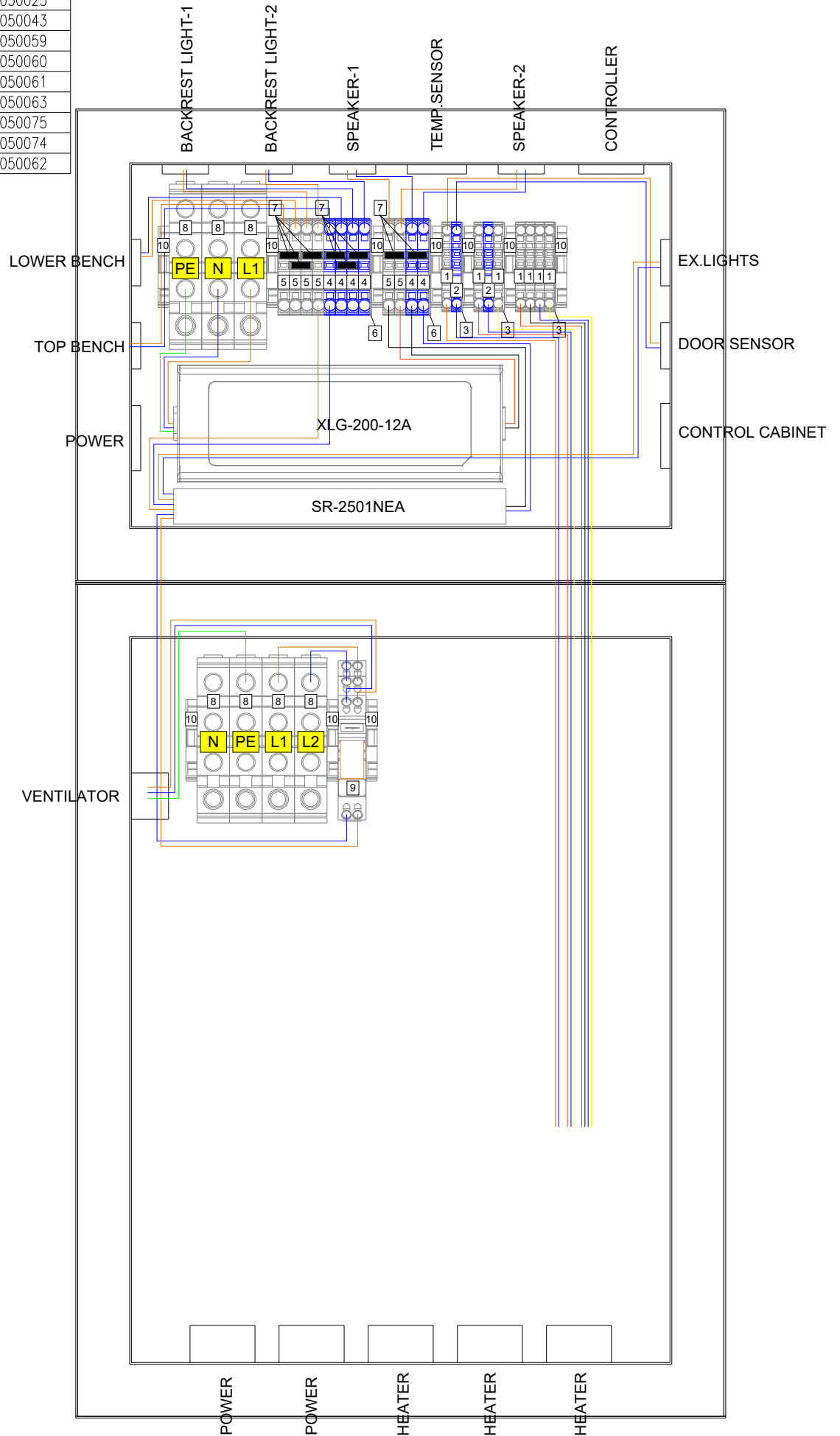

PART SPECIFICATION		
NUMBER	MANUFACTURER CODE	ORDER NR
1	WAGO 2002-1201	9050023
2	WAGO 2002-1204	9050025
3	WAGO 2002-1291	9050043
4	WAGO 2004-1201	9050059
5	WAGO 2004-1204	9050060
6	WAGO 2004-1291	9050061
7	WAGO 2004-402	9050063
8	WAGO 284-621	9050075
9	WAGO 788-311	9050074
10	WAGO 249-116	9050062

Figure 2.  
SAUNUM AIRCUBE SPACE  
CONNECTIONS AFTER SAUNA INSTALLATION

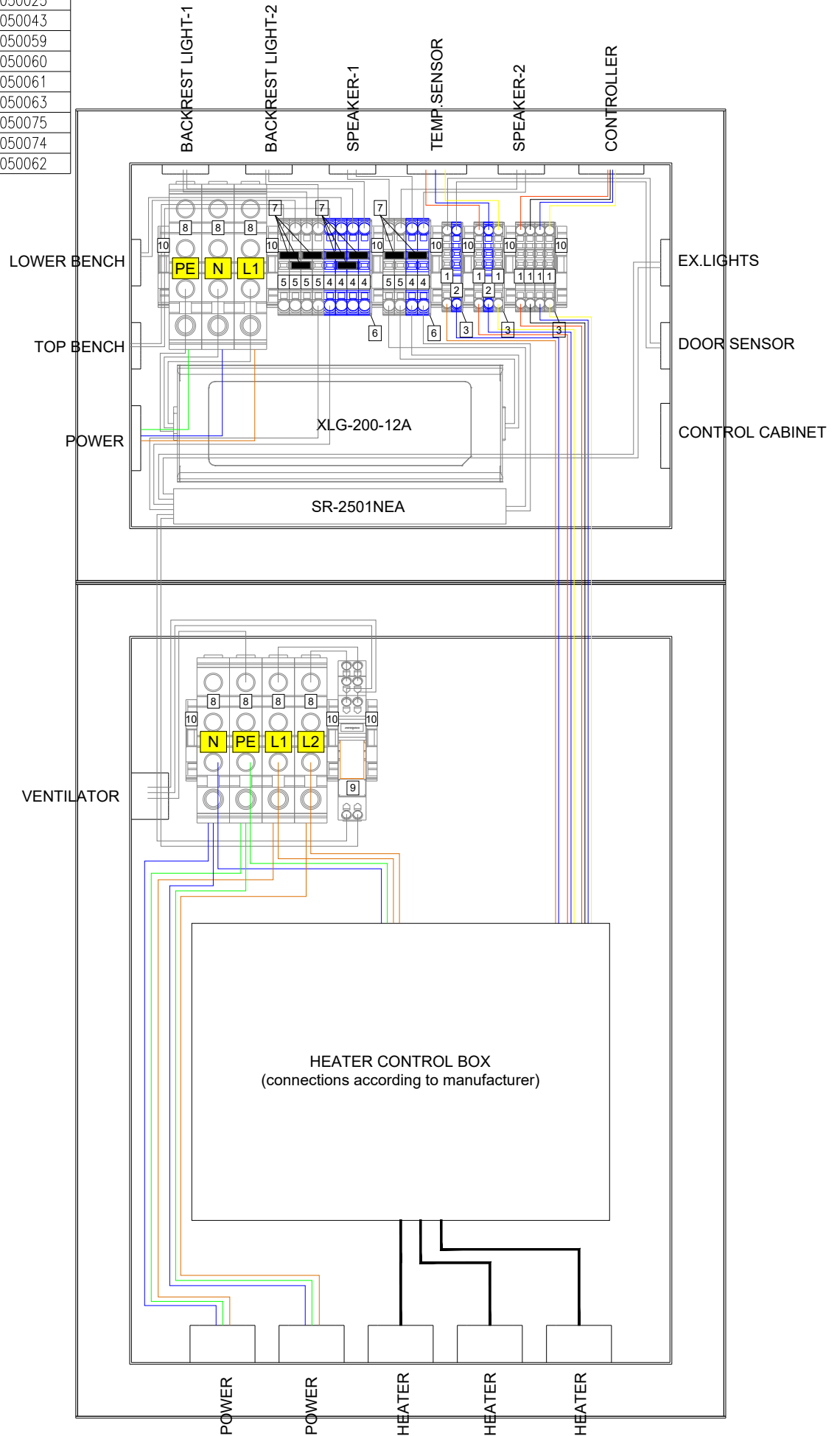

## 7. User guide

### Using and connecting Bluetooth speakers

1. Make sure that Sauna is connected to external power
2. There is a red light on the speakers if they are not connected to any device
3. Turn on Bluetooth on your phone and search for available devices
4. "PROMARINE-BT65" should appear on the list
5. Connect your phone with it and speakers should make a sound to indicate a successful connection
6. Now there should be a blue light on the speakers and they are ready to transmit sound

### Using remote controller

The remote is used to control Sauna's lights and extraction ventilator:

- Channel 1 – interior lights
- Channel 2 – exterior lights
- Channel 3 – ventilator



Inside lights (Channel 1 and 2) are dimmable when holding down ON or OFF button. Other Channels should be controlled by pressing ON/OFF button once, not holding them down.



## 8. Maintenance

### General upkeep

- After each use, ensure that the sauna is properly ventilated. Turn on the ventilation system to help dry out any excessive moisture.
- Gently clean the surfaces of benches and cladding with a damp cloth to remove any sweat or dirt buildup. Do not use harsh chemicals or abrasives which could damage the wood.

### Interior maintenance

- Treat interior wood surfaces with a wood preservative specially formulated for saunas to guard against rot and maintain its resistance to heat and moisture.
- Regularly remove the wooden floor grid and clean underneath. Sweep or vacuum any debris. Clean the wooden floor grid with a damp cloth and a gentle wood cleaner, avoid using excessive water.
- Routinely check corners and crevices for any signs of mold or mildew, treating them promptly if found.

### Exterior care

- Clean the exterior cladding once year using special wood cleaner designed for outdoor use to prevent any mold or mildew formation.
- Check for any chipping or peeling on the exterior surface and reapply a protective finish if necessary.

### General notes

- Never pour water over the heater when it is off.
- Do not leave combustible materials like towels inside the sauna after use.
- Ensure you read and follow all safety instructions provided by your sauna heater manufacturer regarding operation and maintenance activities.
- For any concerns regarding electrical systems, contact certified electricians for inspection and repair. Regularly conducting these maintenance steps will help prolong the life of your sauna and ensure a safe, enjoyable experience.
- Sauna door must be closed during heating to avoid over-heating!

## 9. WARRANTY CONDITIONS FOR SAUNUM SAUNAS

### **Warranty Period:**

The warranty is valid for a period of 2 years from the date of purchase.

Warranty is only valid if the sauna's foundation has been constructed correctly according to the guidelines provided. Improperly constructed foundations will void this warranty.

### **Coverage:**

The warranty covers defects in materials and workmanship of the wooden interior, cladding, bench, wooden frame of the sauna. and the roof covering material

**Interior Elements:** The warranty covers defects in wooden interior cladding and benches, provided the sauna has been used under normal conditions (not for commercial usage) and received proper maintenance as per manufacturer's guidelines. This warranty does not include changes in wood color, texture, or slight warping, which are natural characteristics of wood. Including window frame.

**Structural Integrity:** The wooden frame of the sauna is warranted against defects in workmanship and materials. This does not include minor cosmetic issues which do not affect the performance of the sauna.

**Roof Covering:** Protan the roof covering material is warranted against leaks due to material manufacturing and workmanship defects. The mechanical damage on the Roof covering material will not be covered under warranty.

# saunum

---

## **Exclusions:**

This warranty does not cover any damage or defects resulting from normal wear and tear, lack of maintenance as per instructions, alteration, misuse, or abuse. Man-made injuries or damage caused by accidents, pests, natural disasters or any other external forces and transportation damages are specifically excluded from this warranty.

Warranty is only valid if the sauna's foundation has been constructed correctly according to the guidelines provided. Improperly constructed foundations will void this warranty.

Issues arising from failure to perform maintenance as per provided instructions.

Damage to external painted wooden cladding due to lack of maintenance.

Water damage if a rainwater system is not installed or if it is improperly installed.

The heater unit is excluded from this warranty (sold separately).

The warranty is only valid if heater is installed in strict accordance with the manufacturer's instructions. Improper installation will result in voiding of this warranty.







It is crucial to adhere to all safety distances around the sauna heater as per manufacturer requirements. Failure to keep a safe distance can lead to safety hazards and invalidate this warranty.





The manufacturer's warranty will be voided if any modifications are made to the sauna.

## **Claims Process:**

To file a claim under this warranty, the original purchaser must contact customer service with proof of purchase and detailed description/photos of the defect within the warranty period. The manufacturer reserves the right to inspect the defect before honoring any warranty claim.

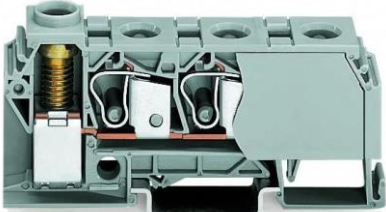
## 10. Spare parts



Order number	Part Name	Part Picture
9050023	Feed-through terminal block	
9050025	Feed-through terminal block	
9050043	End and partition plate for terminal block	
9050059	Feed-through terminal block	
9050060	Feed-through terminal block	
9050061	End and partition plate for terminal block	

Order number	Part Name	Part Picture
9050063	Cross-connector for terminal block	
9050075	Feed-through terminal block	
9050074	Relay module	
9050062	End bracket for terminal block	
9050045	AC-DC Single output LED driver	
9030010	RF dimmer SR-2501NEA	

# saunum

Order number	Part Name	Part Picture
9030011	RF dimmer switch	
2020002	Tangential fan NCA 60-120/23	
9040007	LED STRIP LIGHT	
9040004	Exterior light Forest	
9040008	GU10 spot light bulb	

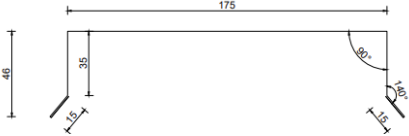
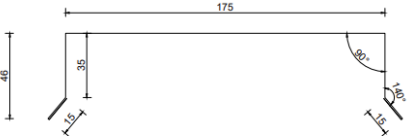
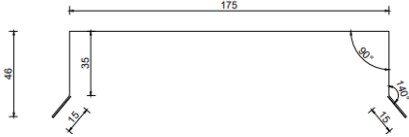
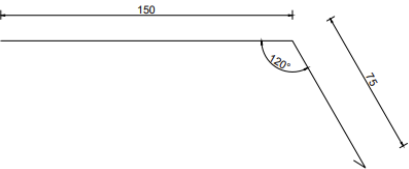
# saunum





Order number	Part Name	Part Picture
9050005	Speakers	
4030065	Parapet metal right	
4030066	Parapet metal left	
4030067	Parapet metal front	
4030068	Roof drip metal	
4030069	Rainwater gutter	

# saunum



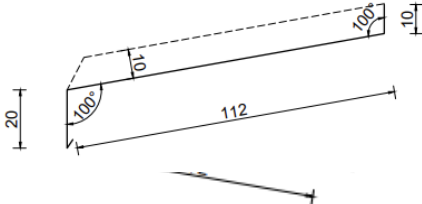
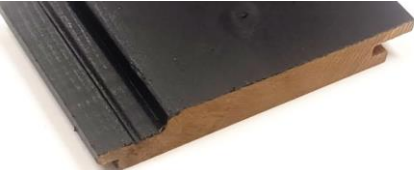

Order number	Part Name	Part Picture
4030004	Rainwater gutter end cap	
4030003	Rainwater gutter bracket	
4030002	Rainwater drop outlet	
4030005	Rainwater down pipe	
4030006	Rainwater down pipe bracket	
4030007	Rainwater outlet	









# saunum

Order number	Part Name	Part Picture
4030070	Window metal	
7060003	Cladding board (1 pc 2,4m)	
7060004	Base board (1 pc 2,8m)	
2020004	Air outlet cover 260x190mm	
2020011	Air inlet cover 140x190mm	



# saunum

Order number	Part Name	Part Picture
7050005	Cladding board STS3 15x120mm (1 pc 2,7m)	
7070053	Bench board 28x120mm (1 pc 2,7m)	
7070053	Backrest board 28x90mm (1 pc 2,4m)	
7070037	Backrest board 28x65mm (1 pc 2,4m)	
7070031	Skirt board 28x42mm (1 pc 2,4m)	
7070025	Floor grid board 28x28mm (1 pc 2,4m)	

# saunum

Order number	Part Name	Part Picture
2020008	Air inlet cover	
2020006	Air outlet cover	
2010003	Trap cover	
5030018	Door hinge	
5030017	CYLINDER ACCESSORY SET	
5030016	Lock case	

# saunum

Order number	Part Name	Part Picture
5030015	Lock cylinder	 A silver-colored lock cylinder with a keyhole and a set of three keys on a ring.
5030014	Concealed door closer	 A long, silver-colored metal door closer with a mounting bracket and a roller.
5030013	Door handle	 A long, silver-colored door handle with a central gold-colored grip and two mounting brackets.

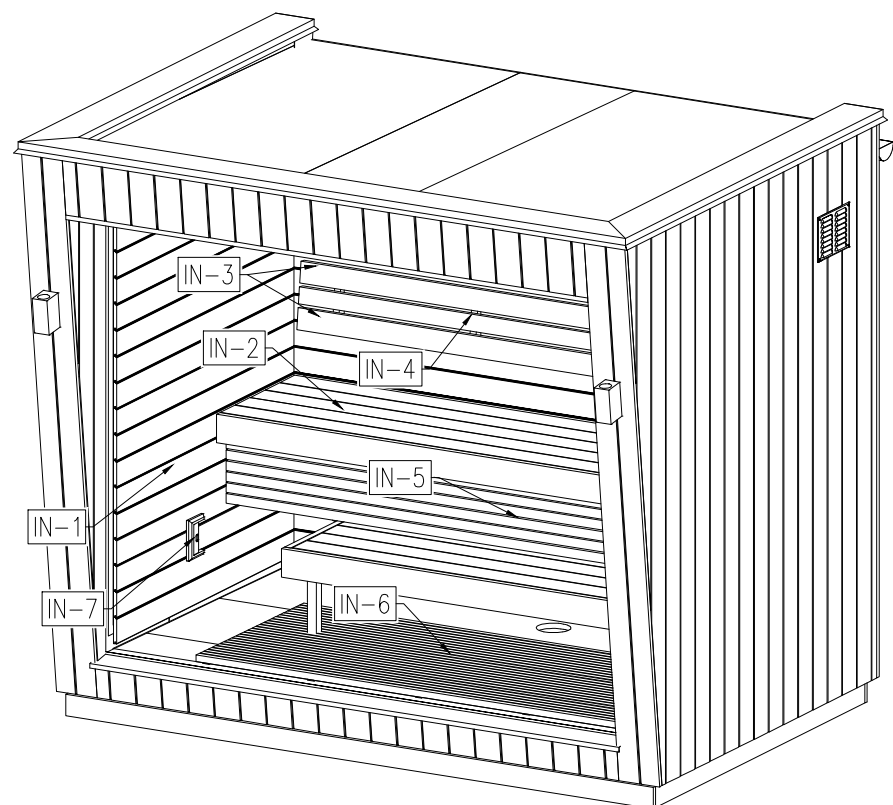
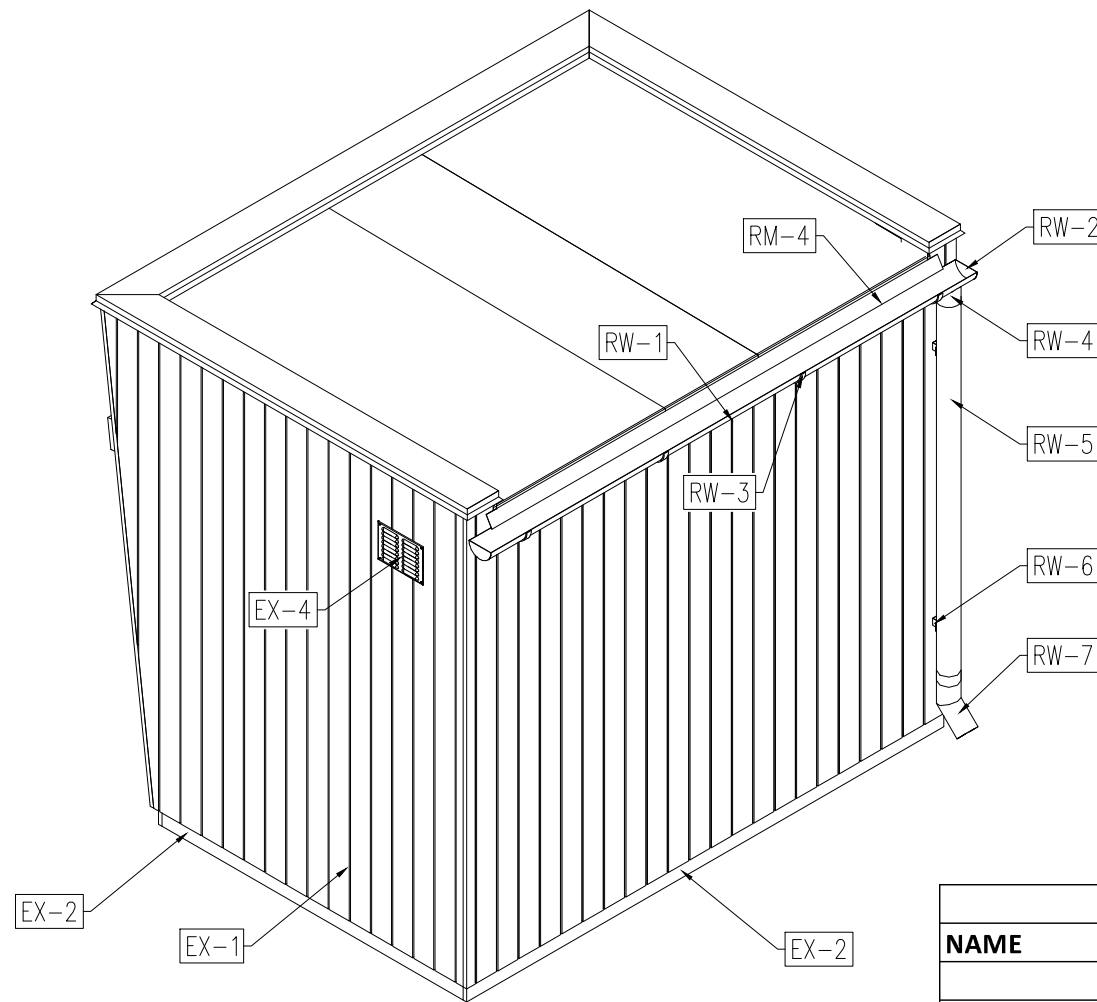
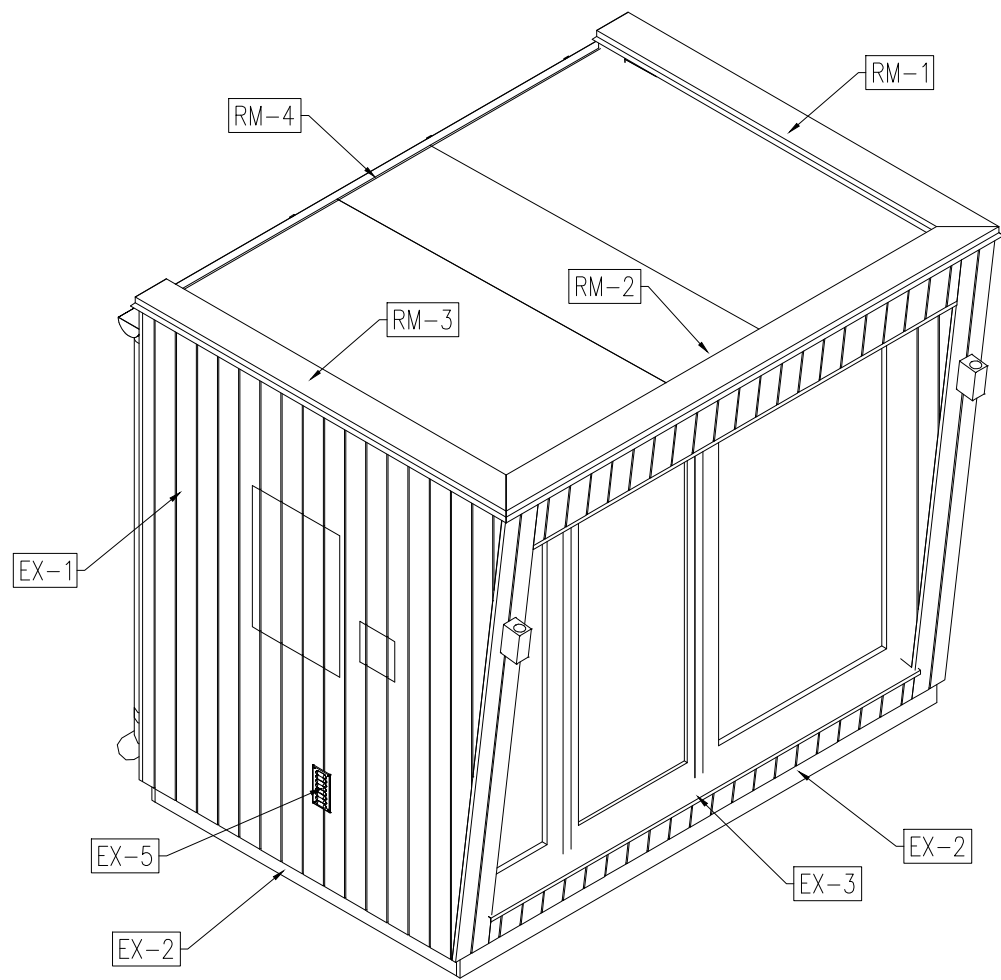

AirCube Space		
NAME	SYMBOL	ORDER NR.
Roof		
Parapet metal right	RM-1	4030051
Parapet metal front	RM-2	4030011
Parapet metal left	RM-3	4030052
Roof drip metal	RM-4	4030014
Rainwater gutter	RW-1	4030015
Rainwater gutter end cap	RW-2	4030004
Rainwater gutter bracket	RW-3	4030003
Rainwater drop outlet	RW-4	4030002
Rainwater down pipe	RW-5	4030005
Rainwater down pipe bracket	RW-6	4030006
Rainwater outlet	RW-7	4030007
External		
Cladding board (1 pc 2,4m)	EX-1	7060003
Base board (1 pc 2,8m)	EX-2	7060004
Window-door metal	EX-3	4030041
Air outlet cover 260x190mm	EX-4	2020004
Air inlet cover 140x190mm	EX-5	2020011
Internal		
Cladding board STS3 15x120mm (1 pc 2,7m)	IN-1	7050005
Bench board 28x120mm (1 pc 2,7m)	IN-2	7070053
Backrest board 28x90mm (1 pc 2,4m)	IN-3	7070053
Backrest board 28x65mm (1 pc 2,4m)	IN-4	7070037
Skirt board 28x42mm (1 pc 2,4m)	IN-5	7070031
Floor grid board 28x28mm (1 pc 2,4m)	IN-6	7070025
Air inlet cover	IN-7	2020008

<b>saunum</b> <small>Saunum Sauna Team OÜ          Registrikood: 14769342          www.saunateam.ee; info@saunum.com</small>	PROJECT	Aicube Space		DRAWING		Spare Parts	
	ADDRESS	-	-	CONTRACT	-	SCALE	-
	DESIGNER	-	-	DATE	26.04.2024	FORMAT	A3
	CODE	-	-	CHECK	M.Ojamaa	PAGE	1/1

